



# FERRAMENTA 2024



## Passione per i particolari

Metal Style, presente da oltre 30 anni sul mercato nazionale, è oggi una realtà consolidata dove la specializzazione di settore, l'attenzione per i dettagli e il gusto per la tradizione sono elementi distintivi.

L'azienda, leader nella produzione e distribuzione di accessori per il mobile, ferramenta e infisso, offre un'ampia gamma di prodotti di pregio, sinonimo di qualità e design, in grado di soddisfare anche la clientela più esigente.

Maniglie ed accessori per mobile per ricreare stili ed epoche del passato, nuovi modelli dalle linee contemporanee e moderne per soddisfare le esigenze di un mercato in continua evoluzione, così come una gamma di prodotti artigianali in ferro che ricreano il calore del pezzo antico e ne conservano il fascino irresistibile.

Metal Style offre diversi servizi per sviluppare e consolidare con i suoi clienti un rapporto di stima e fiducia, prolungato nel tempo, garantendo un servizio di assistenza post-vendita ed una distribuzione capillare con consegne precise e puntuali.

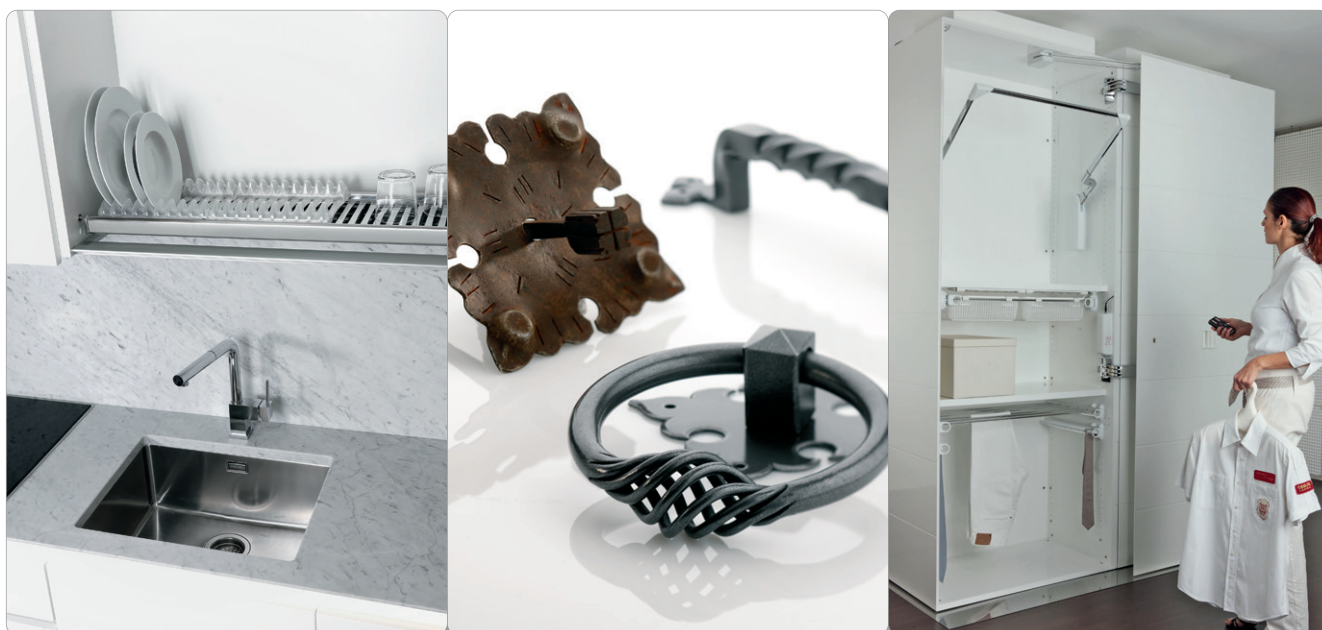

**Prefazione:** Tutte le vendite dei prodotti Metal Group sono regolamentate dalle seguenti condizioni standard di vendita. Queste condizioni sono parte integrante del contratto e si intendono accettate dall'Acquirente anche se da Lui non sottoscritte. Qualsiasi clausola unilaterale specifica dell'acquirente sarà considerata non valida.

- Ordini:**
1. Gli ordini saranno evasi nel limite della disponibilità, senza garanzia del saldo. L'eventuale evasione del saldo sarà effettuata con successiva spedizione (salvo diversa disposizione del cliente che deve essere comunicata al momento della stilatura dell'ordine). Per gli articoli con esigenze di accoppiamento, Vi preghiamo di segnalare chiaramente sull'ordine se devono essere evasi unitamente.
  2. I termini convenuti per la consegna non sono impegnativi. Un eventuale ritardo non può dar luogo, da parte dell'Acquirente, a qualsiasi pretesa di danni, interessi o resi.
  3. Per motivi di gestione, non verranno effettuate bolle di consegna per importi inferiori a 150,00€. Verrà fatta eccezione solo per casi di urgenze o campionature per le quali la scrivente provvederà ad effettuare spedizioni espresse in contrassegno (In ogni caso l'importo minimo per il contrassegno è di € 50,00) ed in porto franco con addebito del trasporto in fattura.
  4. Saranno accettati ordini nel rispetto delle quantità indicate a catalogo (vedi box). Il materiale di fissaggio viene fornito solo su richiesta del cliente e non è incluso nel prezzo. Qualora pervenissero richieste diverse da quanto sopra indicato le stesse saranno evase in conformità delle quantità minime de box.
  5. Le ordinazioni dovranno avvenire indicando i codici completi del catalogo; in caso contrario non assumiamo nessuna responsabilità per eventuali errori nell'evasione degli ordini derivanti da indicazioni insufficienti.
  6. Ci riserviamo il diritto di cambiare le caratteristiche dei prodotti illustrati sul catalogo in ogni momento e senza preavviso.
  7. Le richieste di articoli con quantità inferiore a quella indicata nella colonna box, saranno applicabili solo per gli articoli che prevedono il prezzo nella colonna con la seguente immagine  .
  8. Gli ordini saranno evasi con la massima sollecitudine, in porto assegnato, salvo accordi diversi presi con la scrivente. La merce viaggia a rischio e pericolo del committente, qualunque sia il modo di spedizione.
  9. L'importo minimo da raggiungere per la spedizione in porto franco è di € 1.700.

**Prezzi:** 10. I prezzi potranno subire variazioni senza obbligo alcuno di preavviso alla clientela ( beninteso che è buona abitudine della scrivente redigere un listino prezzi e preavvisare tempestivamente per eventuali aumenti o variazioni) i prezzi sono al netto di Iva.

**Pagamenti:** 11. I pagamenti devono essere effettuati alle condizioni stabilite e senza alcuna detrazione. In caso di insolvenza decorreranno gli interessi di mora dalla scadenza del pagamento, in riferimento al tasso bancario maggiorato di 2 punti percentuali.

**Reclami e resi:** 12. Eventuali reclami dovranno pervenire presso la ns. sede tramite lettera A/R, e-mail o fax, entro e non oltre 8 giorni dal ricevimento della merce. Non vengono presi in considerazione eventuali reclami fatti oltre il termine stabilito o fatti con modalità diverse da quanto sopra riportato. Non si accettano resi se non da noi espressamente autorizzati. La merce deve essere in ogni caso restituita all'azienda in porto franco ed in perfetto stato. Per i resi che non dipendono da errori della scrivente, verrà addebitata una spesa aggiuntiva pari al 10% del valore del materiale reso. Non si accettano resi di articoli speciali, non inseriti a catalogo, espressamente ordinati dal committente.

**Giurisdizione:** 13. Per qualsiasi contestazione è competente il foro di Verona.

***Le predette condizioni si intendono accettate con l'ordinamento della merce.***

©2024 Metal Style

È vietata ogni riproduzione, con qualunque mezzo,  
senza preventiva autorizzazione scritta dalla Metal Style.

Ogni trasgressione sarà punita a norma di legge.

Tutte le misure sono espresse in mm.

Per questioni tecniche, i colori delle immagini  
possono non rappresentare fedelmente la realtà.



# INDICE

## generale

*pag.*

6	 <u>MANIGLIE e POMOLI</u>
12	 <u>CERNIERE e CHIUSURE</u>
27	 <u>Articoli in LEGNO</u>
31	 <u>Ferramenta da MOBILE e CUCINA</u>
42	 <u>Ferramenta per ARMADI e LETTI</u>
51	 <u>MINUTERIA</u>
66	 <u>Indice per codice completo</u>
72	 <u>Indice per codice breve</u>

# MANIGLIE e POMOLI





**NEW** MANIGLIA COLUMNAE



CODICE	COD. BREVE	FINITURA	MAT.	INGOMBRO MM	BOX PZ.
15232Z12800.07	MG41236	Oro Valenza	Zama	128	25
15232Z12800.19	MG41237	Similferro	Zama	128	25
15232Z16000.07	MG44740	Oro Valenza	Zama	160	20
15232Z16000.19	MG44741	Similferro	Zama	160	20



**NEW** POMOLO COLUMNAE



CODICE	COD. BREVE	FINITURA	MAT.	INGOMBRO MM	BOX PZ.
24232Z03000.07	MG41238	Oro Valenza	Zama	30	20
24232Z03000.19	MG41239	Similferro	Zama	30	20



**NEW** MANIGLIA TORUS



CODICE	COD. BREVE	FINITURA	MAT.	INGOMBRO MM	BOX PZ.
15246Z12800.36	MG44742	Cromo Lucido	Zama	128	20
15246Z12800.83	MG44743	Graphite	Zama	128	20



**NEW** POMOLO TORUS



CODICE	COD. BREVE	FINITURA	MAT.	INGOMBRO MM	BOX PZ.
24246Z05000.36	MG44744	Cromo Lucido	Zama	50x11x h.31	20
24246Z05000.83	MG44745	Graphite	Zama	50x11x h.31	20



**NEW** MANIGLIA LITTERA



CODICE	COD. BREVE	FINITURA	MAT.	INGOMBRO MM	BOX PZ.
15245Z12800.19	MG44746	Similferro	Zama	128	20
15245Z12800.DT	MG44747	Gold Treasure	Zama	128	20



**NEW** POMOLO LITTERA



CODICE	COD. BREVE	FINITURA	MAT.	INGOMBRO MM	BOX PZ.
24245Z05000.19	MG44748	Similferro	Zama	50x11x h.29	20
24245Z05000.DT	MG44749	Gold Treasure	Zama	50x11x h.29	20



**NEW** MANIGLIA DECORA



CODICE	COD. BREVE	FINITURA	MAT.	INGOMBRO MM	BOX PZ.
15248Z12800.32	MG44750	Nickel Lucido	Zama	128	20
15248Z12800.83	MG44751	Graphite	Zama	128	20



**NEW** POMOLO DECORA



CODICE	COD. BREVE	FINITURA	MAT.	INGOMBRO MM	BOX PZ.
24248Z05000.32	MG44752	Nickel Lucido	Zama	50x12x h.32	20
24248Z05000.83	MG44753	Graphite	Zama	50x12x h.32	20



**NEW** MANIGLIA ETRURIA



CODICE	COD. BREVE	FINITURA	MAT.	INGOMBRO MM	BOX PZ.
15247Z12800.DT	MG44776	Gold Treasure	Zama	128	20
15247Z12800.N2	MG44777	Nero Opaco	Zama	128	20
15247Z16000.DT	MG44778	Gold Treasure	Zama	160	20
15247Z16000.N2	MG44779	Nero Opaco	Zama	160	20



**NEW** POMOLO ETRURIA



CODICE	COD. BREVE	FINITURA	MAT.	INGOMBRO MM	BOX PZ.
24247Z05000.DT	MG44780	Gold Treasure	Zama	50x15x h.32	20
24247Z05000.N2	MG44781	Nero Opaco	Zama	50x15x h.32	20



**NEW** POMOLO SCACCO



CODICE	COD. BREVE	FINITURA	MAT.	INGOMBRO MM	BOX PZ.
24415Z01500.36	MG44782	Cromo Lucido	Zama	15	20
24415Z02000.36	MG44784	Cromo Lucido	Zama	20	20
24415Z02500.36	MG44786	Cromo Lucido	Zama	25	20
24415Z01500.DT	MG44783	Gold Treasure	Zama	15	20
24415Z02000.DT	MG44785	Gold Treasure	Zama	20	20
24415Z02500.DT	MG44787	Gold Treasure	Zama	25	20



**GAMET®**

**NEW** MANIGLIA



CODICE	COD. BREVE	FINITURA	MAT.	INGOMBRO MM	BOX PZ.
UU17MG45031	MG45031	Nero opaco	Zama	128 mm	25
UU17MG45032	MG45032	Ottone Lucido	Zama	128 mm	25
UU17MG45033	MG45033	Nero opaco	Zama	160 mm	25
UU17MG45034	MG45034	Ottone Lucido	Zama	160 mm	25
UU17MG45035	MG45035	Nero opaco	Zama	320 mm	25
UU17MG45036	MG45036	Ottone Lucido	Zama	320 mm	25

**GAMET®**

**NEW** POMOLO



CODICE	COD. BREVE	FINITURA	MAT.	INGOMBRO MM	BOX PZ.
GU07MG45037	MG45037	Ottone Lucido	Zama	Diam. 20	50
GU07MG45038	MG45038	Nero opaco	Zama	Diam. 20	50

**GAMET®**

**NEW** MANIGLIA

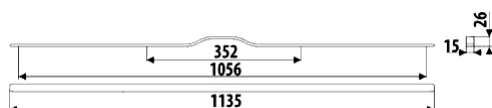
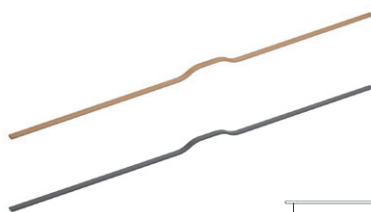

CODICE	COD. BREVE	FINITURA	MAT.	INGOMBRO MM	BOX PZ.
UA130MG45039	MG45039	Oro Satinato	Alluminio	Int. 352 - 1056	10
UA130MG45040	MG45040	Nero opaco	Alluminio	Int. 352 - 1056	10

**GAMET®**

**NEW** MANIGLIA



CODICE	COD. BREVE	FINITURA	MAT.	INGOMBRO MM	BOX PZ.
UA131MG45041	MG45041	Oro Satinato	Alluminio	Int. 352 - 1056	10
UA131MG45042	MG45042	Nero opaco	Alluminio	Int. 352 - 1056	10

**GAMET®**

**NEW** MANIGLIA



CODICE	COD. BREVE	FINITURA	MAT.	INGOMBRO MM	BOX PZ.
RE29MG45043	MG45043	Inox	Acciaio	sezione da 12 - 96 mm	50
RE29MG45044	MG45044	Inox	Acciaio	sezione da 12 - 128 mm	50
RE29MG45045	MG45045	Inox	Acciaio	sezione da 12 - 160 mm	50
RE29MG45046	MG45046	Inox	Acciaio	sezione da 12 - 192 mm	25
RE29MG45047	MG45047	Inox	Acciaio	sezione da 12 - 224 mm	25
RE29MG45048	MG45048	Inox	Acciaio	sezione da 12 - 320 mm	25
RE29MG45049	MG45049	Nero opaco	Acciaio	sezione da 12 - 96 mm	50
RE29MG45050	MG45050	Nero opaco	Acciaio	sezione da 12 - 128 mm	50
RE29MG45051	MG45051	Nero opaco	Acciaio	sezione da 12 - 160 mm	50
RE29MG45052	MG45052	Nero opaco	Acciaio	sezione da 12 - 192 mm	25
RE29MG45053	MG45053	Nero opaco	Acciaio	sezione da 12 - 224 mm	25
RE29MG45054	MG45054	Nero opaco	Acciaio	sezione da 12 - 320 mm	25

**NEW** POMOLO

CODICE	COD. BREVE	FINITURA	MAT.	INGOMBRO MM	BOX PZ.
24VP.001024.F1	MG44646	bianco	Zama	24x24x h.23	50
24VP.001024.N2	MG44645	nero	Zama	24x24x h.23	50
24VP.001024.96	MG44647	cromo opaco	Zama	24x24x h.23	50

**NEW** POMOLO

CODICE	COD. BREVE	FINITURA	MAT.	INGOMBRO MM	BOX PZ.
24VP.001050.F1	MG45184	bianco	Zama	50x50x h.29	25
24VP.001050.N2	MG44643	nero	Zama	50x50x h.29	25
24VP.001050.96	MG44644	cromo opaco	Zama	50x50x h.29	25

## MANIGLIA SEZIONE QUADRATA



CODICE	COD. BREVE	FINITURA	MAT.	INGOMBRO MM	BOX PZ.
UU86MG43762	MG43762	Nickel Satinato	Acciaio	sezione da 10 mm 128	25
UU86MG43763	MG43763	Cromo Opaco	Acciaio	sezione da 10 mm 128	25
UU86MG43764	MG43764	Nero	Acciaio	sezione da 10 mm 128	25
UU86MG43765	MG43765	Ottone satinato	Acciaio	sezione da 10 mm 128	25
UU86MG43766	MG43766	Nickel Satinato	Acciaio	sezione da 10 mm 160	25
UU86MG43767	MG43767	Cromo Opaco	Acciaio	sezione da 10 mm 160	25
UU86MG43768	MG43768	Nero	Acciaio	sezione da 10 mm 160	25
UU86MG43769	MG43769	Ottone satinato	Acciaio	sezione da 10 mm 160	25
UU86MG43770	MG43770	Nickel Satinato	Acciaio	sezione da 10 mm 320	25
UU86MG43771	MG43771	Cromo Opaco	Acciaio	sezione da 10 mm 320	25
UU86MG43772	MG43772	Nero	Acciaio	sezione da 10 mm 320	25
UU86MG43773	MG43773	Ottone satinato	Acciaio	sezione da 10 mm 320	25

## TIRETTO



CODICE	COD. BREVE	FINITURA	MAT.	INGOMBRO MM	BOX PZ.
GS86MG43774	MG43774	Nickel Satinato	Acciaio	sezione 10 - L.50 x h.35	25
GS86MG43775	MG43775	Cromo Opaco	Acciaio	sezione 10 - L.50 x h.35	25
GS86MG43776	MG43776	Nero	Acciaio	sezione 10 - L.50 x h.35	25
GS86MG43777	MG43777	Ottone satinato	Acciaio	sezione 10 - L.50 x h.35	25

MANIGLIA



CODICE	COD. BREVE	FINITURA	MAT.	INGOMBRO MM	BOX PZ.
UU16MG43778	MG43778	Ottone satinato	Zama	128 mm	25
UU16MG43779	MG43779	Ottone satinato	Zama	160 mm	25
UU16MG43780	MG43780	Ottone satinato	Zama	320 mm	25

MANIGLIA



CODICE	COD. BREVE	FINITURA	MAT.	INGOMBRO MM	BOX PZ.
UU56MG43781	MG43781	Ottone satinato	Zama	128 mm	25
UU56MG43782	MG43782	Ottone satinato	Zama	160 mm	25
UU56MG43783	MG43783	Ottone satinato	Zama	320 mm	20

POMOLO



CODICE	COD. BREVE	FINITURA	MAT.	INGOMBRO MM	BOX PZ.
GN56MG43784	MG43784	Ottone satinato	Zama	22 x 19 h27	50

MANIGLIA

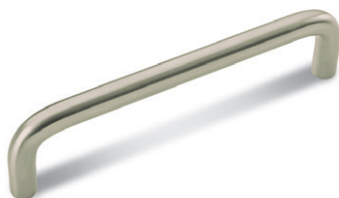

CODICE	COD. BREVE	FINITURA	MAT.	INGOMBRO MM	BOX PZ.
US10MG23722	MG23722	Cromo	Acciaio	sezione da 8 mm 64	50
US10MG23723	MG23723	Cromo	Acciaio	sezione da 8 mm 96	50
US10MG23724	MG23724	Cromo	Acciaio	sezione da 8 mm 128	50
US10MG40252	MG40252	Nero	Acciaio	sezione da 8 mm 64	50
US10MG40253	MG40253	Nero	Acciaio	sezione da 8 mm 96	50
US10MG43760	MG43760	Nero	Acciaio	sezione da 8 mm 128	50
US10MG41745	MG41745	Bianco	Acciaio	sezione da 8 mm 64	50
US10MG41746	MG41746	Bianco	Acciaio	sezione da 8 mm 96	50
US10MG43761	MG43761	Bianco	Acciaio	sezione da 8 mm 128	50

GANCIO APPENDIABITO PIEGHEVOLE

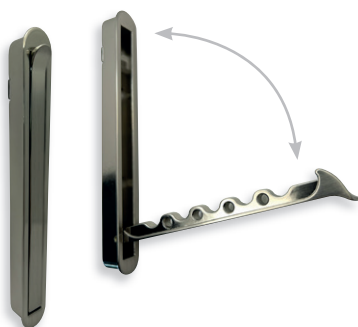

CODICE	COD. BREVE	FINITURA	MAT.	INGOMBRO MM	BOX PZ.
43245Z14000.36	MG44434	Cromo Lucido	Zama	16 x 140 prof. 13,5	10
43245Z14000.34	MG44435	Nickel Satinato	Zama	16 x 140 prof. 13,5	10

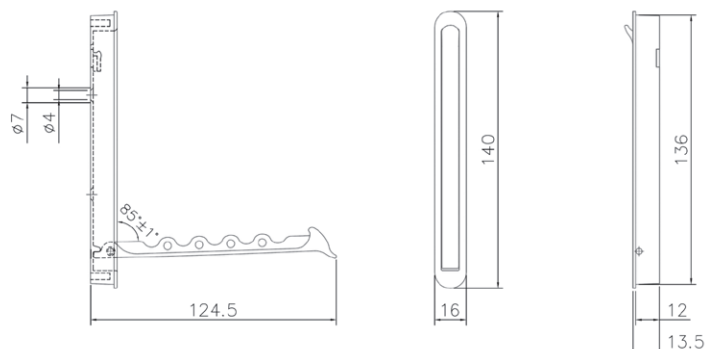

# CERNIERE e CHIUSURE

## CERNIERA AMMORTIZZATA CON BASETTA 3D

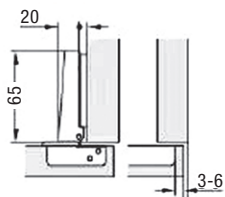

CODICE	COD. BREVE	FINITURA	MAT.	DESCRIZIONE	BOX PZ.
48270.00000.32	MG44264	Nichelata	Ferro	collo zero <b>con basetta 3D</b>	100

Battuta frontale (mm)	14,5	15,5	16,5	17,5
Distanza foratura fondello (mm)	3	4	5	6

## CERNIERA AMMORTIZZATA CON BASETTA 3D

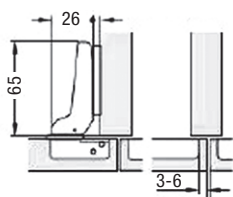

CODICE	COD. BREVE	FINITURA	MAT.	DESCRIZIONE	BOX PZ.
48270.00001.32	MG44265	Nichelata	Ferro	mezzo collo <b>con basetta 3D</b>	100

Battuta frontale (mm)	4,5	5,5	6,5	7,5
Distanza foratura fondello (mm)	3	4	5	6

## CERNIERA AMMORTIZZATA CON BASETTA 3D

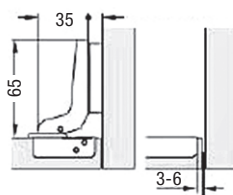

CODICE	COD. BREVE	FINITURA	MAT.	DESCRIZIONE	BOX PZ.
48270.00002.32	MG44266	Nichelata	Ferro	collo alto <b>con basetta 3D</b>	100

Battuta frontale (mm)	-3,5	-2,5	-1,5	-0,5
Distanza foratura fondello (mm)	3	4	5	6

## CERNIERA AMMORTIZZATA CON BASETTA 3D

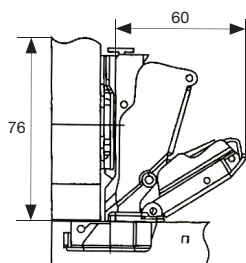
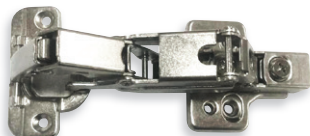

CODICE	COD. BREVE	FINITURA	MAT.	DESCRIZIONE	BOX PZ.
48270.00004.32	MG44267	Nichelata	Ferro	165° <b>con basetta 3D</b>	25

Battuta frontale (mm)	17	18	19	20	21
Distanza foratura fondello (mm)	3	4	5	6	7

**NEW** PIASTRA DI RIPARAZIONE PER CERNIERE

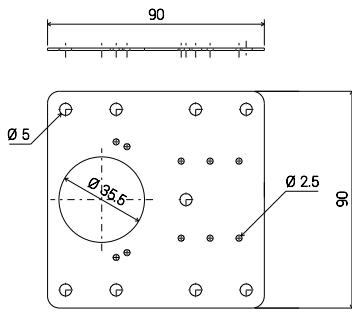

CODICE	COD. BREVE	MATERIALE	BOX PZ.
41069.09000.00	MG46133	Acciaio Inox	50

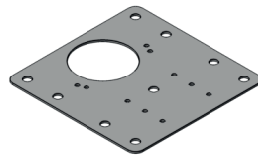

CERNIERA INCASSO



CODICE	COD. BREVE	FINITURA	MAT.	INGOMBRO MM	BOX PZ.
48084Z04000.05	MG11928	Brunita	Zama	diam. perno 6 mm - foro 35 mm	50

CERNIERA INCASSO



CODICE	COD. BREVE	FINITURA	MAT.	INGOMBRO MM	BOX PZ.
48245Z01800.04	MG42562	Bronzata	Zama	diam. perno 6 mm - base 18 mm	50
48245Z01800.10	MG42563	Ottonata	Zama	diam. perno 6 mm - base 18 mm	50
48245Z02400.04	MG42565	Bronzata	Zama	diam. perno 6 mm - base 24 mm	50
48245Z02400.10	MG42566	Ottonata	Zama	diam. perno 6 mm - base 24 mm	50

CERNIERA INCASSO



CODICE	COD. BREVE	FINITURA	MAT.	INGOMBRO MM	BOX PZ.
48246Z06200.10	MG42568	Ottonata	Zama	diam. perno 9 - mm 62x44 - foro 35	25
48246Z06200.04	MG42569	Bronzata	Zama	diam. perno 9 - mm 62x44 - foro 35	25

CERNIERA INCASSO

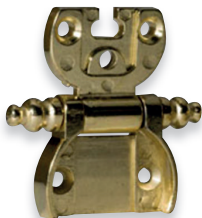

CODICE	COD. BREVE	FINITURA	MAT.	INGOMBRO MM	BOX PZ.
48247Z05000.10	MG42570	Ottonata	Zama	diam. perno 9 - mm 50x49 - foro 35	25
48247Z05000.04	MG42571	Bronzata	Zama	diam. perno 9 - mm 50x49 - foro 35	25

CERNIERA INCASSO



CODICE	COD. BREVE	FINITURA	MAT.	INGOMBRO MM	BOX PZ.
48248Z07000.10	MG42572	Ottonata	Zama	diam. perno 9 - mm 70x60 - foro 35	25
48248Z07000.04	MG42573	Bronzata	Zama	diam. perno 9 - mm 70x60 - foro 35	25

**CERNIERA ZANCATA**

CODICE	COD. BREVE	FINITURA	MAT.	INGOMBRO MM	BOX PZ.
48249Z08000.04	MG42574	Bronzata	Zama	diam. perno 9 - h80 mm	25
48249Z08000.10	MG42575	Ottonata	Zama	diam. perno 9 - h80 mm	25
48249Z10500.04	MG42576	Bronzata	Zama	diam. perno 9 - h105 mm	25
48249Z10500.10	MG42577	Ottonata	Zama	diam. perno 9 - h105 mm	25

**CERNIERA ZANCATA**

CODICE	COD. BREVE	FINITURA	MAT.	INGOMBRO MM	BOX PZ.
48250Z07500.04	MG42578	Bronzata	Zama	diam. perno 6 - h75 mm	25
48250Z07500.10	MG42579	Ottonata	Zama	diam. perno 6 - h75 mm	25

**CERNIERA ZANCATA**

CODICE	COD. BREVE	FINITURA	MAT.	INGOMBRO MM	BOX PZ.
48251Z05200.04	MG42580	Bronzata	Zama	diam. perno 8 - foro 35 mm	25
48251Z05200.10	MG42581	Ottonata	Zama	diam. perno 8 - foro 35 mm	25

**CERNIERA CON ASOLA**

CODICE	COD. BREVE	FINITURA	MAT.	INGOMBRO MM	BOX PZ.
48224.04000.04	MG28721	Bronzato	Zama	diam. perno 5 - 40x37 collo basso	50
48224.04001.04	MG29775	Bronzato	Zama	diam. perno 5 - 40x42 collo alto	50

**CERNIERA ANUBA**

CODICE	COD. BREVE	FINITURA	MAT.	INGOMBRO MM	BOX PZ.
48098.01200.03	MG11968	Ottone antico	Ferro	diam. perno 9 - h12	100
48098.01200.05	MG11969	Nero	Ferro	diam. perno 9 - h12	100
48098.01200.27	MG11971	Ferro vecchio	Ferro	diam. perno 9 - h12	100

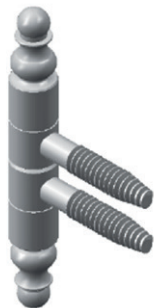
**CERNIERA ANUBA**

CODICE	COD. BREVE	FINITURA	MAT.	INGOMBRO MM	BOX PZ.
48260.06600.04	MG42958	Bronzato	Ferro	diam. perno 9 mm h66	50
48260.06600.17	MG42959	Ottonato	Ferro	diam. perno 9 mm h66	50
48260.06600.DC	MG42960	Bronzato Chiaro	Ferro	diam. perno 9 mm h66	50
48260.08000.04	MG42961	Bronzato	Ferro	diam. perno 11 mm h80	50
48260.08000.17	MG42962	Ottonato	Ferro	diam. perno 11 mm h80	50
48260.08000.DC	MG42963	Bronzato Chiaro	Ferro	diam. perno 11 mm h80	50

**CERNIERA PIANA**

CODICE	COD. BREVE	FINITURA	MAT.	INGOMBRO MM	BOX PZ.
48033.08800.03	MG11684	Ottone antico	Ferro	diam. perno 8 - 88x52	50
48033.08800.05	MG11685	Nero	Ferro	diam. perno 8 - 88x52	50
48033.08800.27	MG11687	Ferro vecchio	Ferro	diam. perno 8 - 88x52	50



CERNIERA PIANA A GIGLIO

CODICE	COD. BREVE	FINITURA	MAT.	INGOMBRO MM	BOX PZ.
48028.08500.03	MG42964	Ottone Antico	Ferro	diam. perno 8 - 85x52	50
48028.08500.27	MG11670	Ferro Vecchio	Ferro	diam. perno 8 - 85x52	50
48028.08500.05	MG42538	Nero	Ferro	diam. perno 8 - 85x52	50



CERNIERA PIANA

CODICE	COD. BREVE	FINITURA	MAT.	INGOMBRO MM	BOX PZ.
48267.11100.05	MG44033	Nero	ferro	L.mm.111 x H.mm.69	50
48267.15100.05	MG44030	Nero	ferro	L.mm.151 x H.mm.95	50



CERNIERA ZANCATA

CODICE	COD. BREVE	FINITURA	MAT.	INGOMBRO MM	BOX PZ.
48268.10400.05	MG44034	Nero	ferro	L.mm.104 x H.mm.69	50
48268.14500.05	MG44031	Nero	ferro	L.mm.145 x H.mm.95	50



CERNIERA PIANA

CODICE	COD. BREVE	FINITURA	MAT.	INGOMBRO MM	BOX PZ.
48269.07000.05	MG44035	Nero	ferro	L.mm.38 x H.mm.70	50
48269.09600.05	MG44032	Nero	ferro	L.mm.67 x H.mm.96	50



CERNIERA INVISIBILE

CODICE	COD. BREVE	FINITURA	MAT.	INGOMBRO MM	BOX PZ.
48021.01000.40	MG11649	Ottone	Ottone	Ø10x22	24
48021.01200.40	MG11650	Ottone	Ottone	Ø12x27	24
48021.01400.40	MG11651	Ottone	Ottone	Ø14x31	24
48021.01600.40	MG42723	Ottone	Ottone	Ø16x33	24
48021.01800.40	MG42724	Ottone	Ottone	Ø18x36	24



CERNIERA IN OTTONE FRESATA DOPPIA CURVA

CODICE	COD. BREVE	FINITURA	MAT.	INGOMBRO MM	BOX PZ.
48256.03535.40	MG43001	Ottone	Ottone	35x35	24
48256.04035.40	MG43002	Ottone	Ottone	40x35	24
48256.04040.40	MG43003	Ottone	Ottone	40x40	24
48256.05040.40	MG43004	Ottone	Ottone	50x40	24
48256.05050.40	MG43005	Ottone	Ottone	50x50	24
48256.06050.40	MG43006	Ottone	Ottone	60x50	24
48256.07055.40	MG43007	Ottone	Ottone	70x55	24
48256.03535.04	MG43015	Bronzato	Ottone	35x35	24
48256.04035.04	MG43016	Bronzato	Ottone	40x35	24
48256.04040.04	MG43017	Bronzato	Ottone	40x40	24
48256.05040.04	MG43018	Bronzato	Ottone	50x40	24
48256.05050.04	MG43019	Bronzato	Ottone	50x50	24
48256.06050.04	MG43020	Bronzato	Ottone	60x50	24
48256.07055.04	MG43021	Bronzato	Ottone	70x55	24

## CERNIERA IN OTTONE FRESATA PIANA



CODICE	COD. BREVE	FINITURA	MAT.	INGOMBRO MM	BOX PZ.
48015.02500.40	MG11621	Ottone	Ottone	25x25	24
48015.03025.40	MG42965	Ottone	Ottone	30x25	24
48015.03000.40	MG11623	Ottone	Ottone	30x30	24
48015.03530.40	MG42966	Ottone	Ottone	35x30	24
48015.03500.40	MG11625	Ottone	Ottone	35x35	24
48015.04030.40	MG42967	Ottone	Ottone	40x30	24
48015.04035.40	MG42968	Ottone	Ottone	40x35	24
48015.04000.40	MG11627	Ottone	Ottone	40x40	24
48015.05030.40	MG42969	Ottone	Ottone	50x30	24
48015.05040.40	MG42970	Ottone	Ottone	50x40	24
48015.05000.40	MG11630	Ottone	Ottone	50x50	24
48015.06040.40	MG42971	Ottone	Ottone	60x40	24
48015.06050.40	MG42972	Ottone	Ottone	60x50	24
48015.07055.40	MG42973	Ottone	Ottone	70x55	24
48015.02500.32	MG42974	Nichel Lucido	Ottone	25x25	24
48015.03025.32	MG42975	Nichel Lucido	Ottone	30x25	24
48015.03000.32	MG42976	Nichel Lucido	Ottone	30x30	24
48015.03530.32	MG42977	Nichel Lucido	Ottone	35x30	24
48015.03500.32	MG42978	Nichel Lucido	Ottone	35x35	24
48015.04030.32	MG42979	Nichel Lucido	Ottone	40x30	24
48015.04035.32	MG42980	Nichel Lucido	Ottone	40x35	24
48015.04000.32	MG42981	Nichel Lucido	Ottone	40x40	24
48015.05030.32	MG42982	Nichel Lucido	Ottone	50x30	24
48015.05040.32	MG42983	Nichel Lucido	Ottone	50x40	24
48015.05000.32	MG11628	Nichel Lucido	Ottone	50x50	24
48015.06040.32	MG42984	Nichel Lucido	Ottone	60x40	24
48015.06050.32	MG42985	Nichel Lucido	Ottone	60x50	24
48015.07055.32	MG42986	Nichel Lucido	Ottone	70x55	24
48015.02500.04	MG11620	Bronzato	Ottone	25x25	24
48015.03025.04	MG42988	Bronzato	Ottone	30x25	24
48015.03000.04	MG11622	Bronzato	Ottone	30x30	24
48015.03530.04	MG42990	Bronzato	Ottone	35x30	24
48015.03500.04	MG11624	Bronzato	Ottone	35x35	24
48015.04030.04	MG42992	Bronzato	Ottone	40x30	24
48015.04035.04	MG42993	Bronzato	Ottone	40x35	24
48015.04000.04	MG11626	Bronzato	Ottone	40x40	24
48015.05030.04	MG42995	Bronzato	Ottone	50x30	24
48015.05040.04	MG42996	Bronzato	Ottone	50x40	24
48015.05000.04	MG11629	Bronzato	Ottone	50x50	24
48015.06040.04	MG42998	Bronzato	Ottone	60x40	24
48015.06050.04	MG42999	Bronzato	Ottone	60x50	24
48015.07055.04	MG43000	Bronzato	Ottone	70x55	24





CERNIERA PIANA CON ASTUCCIO

CODICE	COD. BREVE	FINITURA	MAT.	INGOMBRO MM	BOX PZ.
48022.04000.40	MG11654	Ottone	Ottone	40x40 - Collo 0	50
48022.04000.03	MG11652	Ottone Antico	Ottone	40x40 - Collo 0	50
48022.04000.04	MG11653	Bronzato	Ottone	40x40 - Collo 0	50



CERNIERA ZANCATA CON ASTUCCIO

CODICE	COD. BREVE	FINITURA	MAT.	INGOMBRO MM	BOX PZ.
48023.00800.40	MG11656	Ottone	Ottone	40x40 - Collo 8	50
48023.01000.40	MG11659	Ottone	Ottone	40x35 - Collo 10	50
48023.01300.40	MG11661	Ottone	Ottone	40x35 - Collo 13	50
48023.00800.03	MG11655	Ottone Antico	Ottone	40x40 - Collo 8	50
48023.01000.03	MG11657	Ottone Antico	Ottone	40x35 - Collo 10	50
48023.01300.03	MG11660	Ottone Antico	Ottone	40x35 - Collo 13	50
48023.00800.04	MG43022	Bronzato	Ottone	40x40 - Collo 8	50
48023.01000.04	MG11658	Bronzato	Ottone	40x35 - Collo 10	50
48023.01300.04	MG11662	Bronzato	Ottone	40x35 - Collo 13	50



CERNIERA C/ASOLA TUTTA TONDA

CODICE	COD. BREVE	FINITURA	MAT.	INGOMBRO MM	BOX PZ.
48257.04000.40	MG43024	Ottone	Ottone	40x40 - Collo 0	50
48257.04000.04	MG43025	Bronzato	Ottone	40x40 - Collo 0	50



SOLO ASTUCCIO PER CERNIERE

CODICE	COD. BREVE	FINITURA	MAT.	BOX PZ.
48258.04000.40	MG43026	Ottone	Zama	50
48258.04000.03	MG43027	Ottone Antico	Zama	50
48258.04000.04	MG43028	Bronzato	Zama	50



CERNIERA CON FERMO

CODICE	COD. BREVE	FINITURA	MAT.	INGOMBRO MM	BOX PZ.
48025.08000.40	MG43029	Ottone	Ottone	30x80	24
48025.08000.04	MG43030	Bronzato	Ottone	30x80	24
48025.08000.32	MG11664	Nickel Lucido	Ottone	30x80	24

## CERNIERA SPINA FISSA

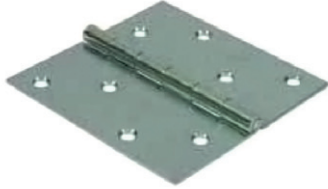

CODICE	COD. BREVE	FINITURA	MAT.	INGOMBRO MM	BOX PZ.
48252.03030.33	MG42857	Zincata	Ferro	30x30	50
48252.04035.33	MG42858	Zincata	Ferro	40x35	50
48252.04040.33	MG42859	Zincata	Ferro	40x40	50
48252.05040.33	MG42860	Zincata	Ferro	50x40	50
48252.05050.33	MG42861	Zincata	Ferro	50x50	50
48252.06050.33	MG42862	Zincata	Ferro	60x50	50
48252.07055.33	MG42863	Zincata	Ferro	70x55	50
48252.03030.17	MG42864	Ottonata	Ferro	30x30	50
48252.04035.17	MG42865	Ottonata	Ferro	40x35	50
48252.04040.17	MG42866	Ottonata	Ferro	40x40	50
48252.05040.17	MG42867	Ottonata	Ferro	50x40	50
48252.05050.17	MG42868	Ottonata	Ferro	50x50	50
48252.06050.17	MG42869	Ottonata	Ferro	60x50	50
48252.07055.17	MG42870	Ottonata	Ferro	70x55	50

## CERNIERA CON FORI TIPO STRETTO



CODICE	COD. BREVE	FINITURA	MAT.	INGOMBRO MM	BOX PZ.
48254.03000.33	MG43031	Zincata	Ferro	30x20	50
48254.04000.33	MG43032	Zincata	Ferro	40x25	50
48254.05000.33	MG43033	Zincata	Ferro	50x30	50
48254.06000.33	MG43034	Zincata	Ferro	60x30	50
48254.07000.33	MG43035	Zincata	Ferro	70x37	50
48254.03000.17	MG43036	Ottonata	Ferro	30x20	50
48254.04000.17	MG43037	Ottonata	Ferro	40x25	50
48254.05000.17	MG43038	Ottonata	Ferro	50x30	50
48254.06000.17	MG43039	Ottonata	Ferro	60x30	50
48254.07000.17	MG43040	Ottonata	Ferro	70x37	50

## CERNIERA A BISCOTTO

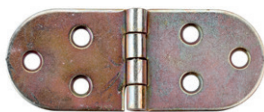

CODICE	COD. BREVE	FINITURA	MAT.	INGOMBRO MM	BOX PZ.
48024.08000.17	MG43041	Ottonata	Ferro	80x31	50
48024.08000.64	MG11663	Tropicalizzata	Ferro	80x31	50
48024.08000.32	MG43042	Nichelata	Ferro	80x31	50

## CERNIERA TIPO LUNGO A SPINA FISSA



CODICE	COD. BREVE	FINITURA	MAT.	INGOMBRO MM	BOX PZ.
48255.04000.33	MG43043	Zincata	Ferro	40x25	50
48255.05000.33	MG43044	Zincata	Ferro	50x25	50
48255.06000.33	MG43045	Zincata	Ferro	60x25	50
48255.08000.33	MG43046	Zincata	Ferro	80x25	50
48255.10000.33	MG43047	Zincata	Ferro	100x25	50
48255.12000.33	MG43048	Zincata	Ferro	120x25	50
48255.14000.33	MG43049	Zincata	Ferro	140x25	50
48255.16000.33	MG43050	Zincata	Ferro	160x25	50

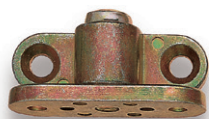

GIUNZIONE

CODICE	COD. BREVE	FINITURA	MAT.	INGOMBRO MM	BOX PZ.
41012Z04000.17	MG10179	Ottonato	Zama	39x15	100



CRICCHETTO

CODICE	COD. BREVE	FINITURA	MAT.	INGOMBRO MM	BOX PZ.
39085.03200.DC	MG9678	Bronzato	Ferro	30x32	100



CRICCHETTO 2 SFERE

CODICE	COD. BREVE	FINITURA	MAT.	INGOMBRO MM	BOX PZ.
39086.04400.66	MG9679	Ottone Lucido	Ottone	8x44	24
39086.04400.04	MG42539	Bronzato	Ottone	8x44	24
39086.04400.32	MG42540	Nichelato	Ottone	8x44	24
39086.04900.66	MG9680	Ottone Lucido	Ottone	9x49	24
39086.04900.04	MG42541	Bronzato	Ottone	9x49	24
39086.04900.32	MG42542	Nichelato	Ottone	9x49	24
39086.06000.66	MG42543	Ottone Lucido	Ottone	11x60	24
39086.06000.04	MG42544	Bronzato	Ottone	11x60	24
39086.06000.32	MG42545	Nichelato	Ottone	11x60	24



CHIUSURA A SCATTO

CODICE	COD. BREVE	FINITURA	MAT.	INGOMBRO MM	BOX PZ.
39087.03300.F1	MG42671	Nickel/bianco	Ferro + Plastica	26x33x11	50
39087.03300.G1	MG42672	Nickel/marrone	Ferro + Plastica	26x33x11	50



CHIUSURA MAGNETICA PICCOLA K6

CODICE	COD. BREVE	FINITURA	MAT.	INGOMBRO MM	BOX PZ.
39078.04800.G1	MG9664	Marrone	Ferro + Plastica	48 x 15	100
39078.04800.F1	MG42871	Bianco	Ferro + Plastica	48 x 15	100



CHIUSURA MAGNETICA GRANDE K12

CODICE	COD. BREVE	FINITURA	MAT.	INGOMBRO MM	BOX PZ.
39078.08700.G1	MG42872	Marrone	Ferro + Plastica	87 x 18	50
39078.08700.F1	MG42873	Bianco	Ferro + Plastica	87 x 18	50

**CRICCHETTO PUSH TO OPEN - Testato per 100.000 cicli**



CODICE	COD. BREVE	FINITURA	MAT.	DESCRIZIONE	BOX PZ.
39133.00000.83	MG42877	Antracite	Plastica	Con magnete	50
39133.00001.83	MG42878	Antracite	Plastica	Con paracolpo	50



39133.000BS.83	MG42896	Antracite	Plastica	Base e Supporto	50
----------------	---------	-----------	----------	-----------------	----

**CRICCHETTO PUSH TO OPEN - Testato per 100.000 cicli**



CODICE	COD. BREVE	FINITURA	MAT.	DESCRIZIONE	BOX PZ.
39133.00000.P2	MG42879	Grigio chiaro	Plastica	Con magnete	50
39133.00001.P2	MG42880	Grigio chiaro	Plastica	Con paracolpo	50



39133.000BS.P2	MG42897	Grigio chiaro	Plastica	Base e Supporto	50
----------------	---------	---------------	----------	-----------------	----

**CRICCHETTO PUSH TO OPEN - Testato per 100.000 cicli**



CODICE	COD. BREVE	FINITURA	MAT.	DESCRIZIONE	BOX PZ.
39133.00000.F1	MG42881	Bianco	Plastica	Con magnete	50
39133.00001.F1	MG42882	Bianco	Plastica	Con paracolpo	50



39133.000BS.F1	MG42898	Bianco	Plastica	Base e Supporto	50
----------------	---------	--------	----------	-----------------	----

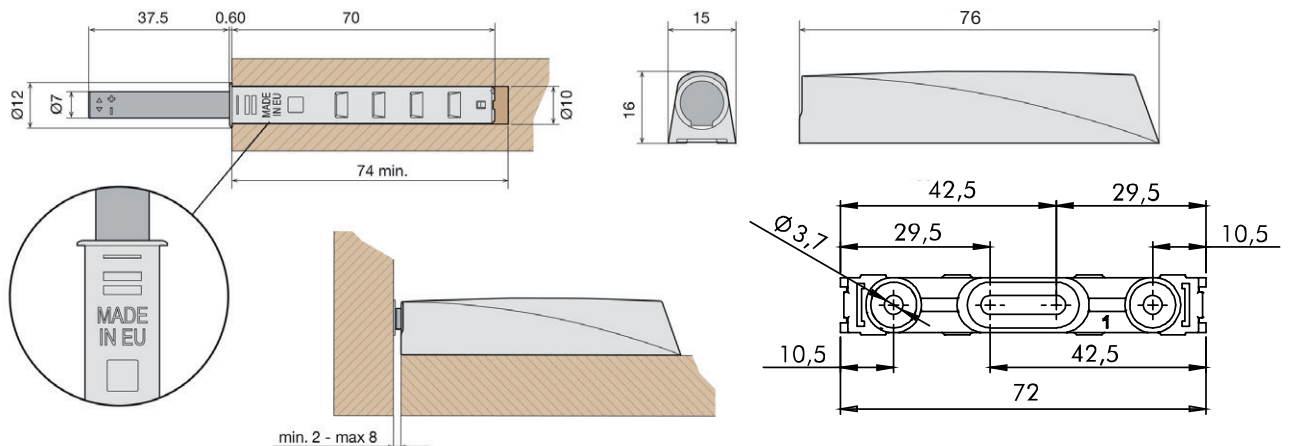

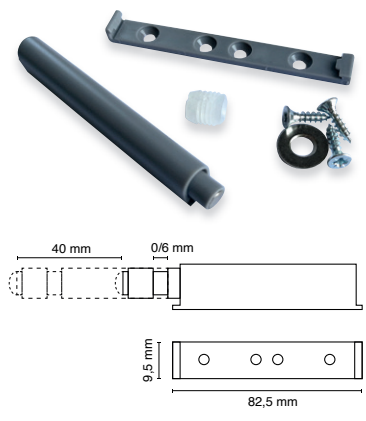

**CRICCHETTO**

CODICE	COD. BREVE	FINITURA	MAT.	DESCRIZIONE	BOX PZ.
39132.12000.P2	MG42681	Grigio	Plastica	Con magnete	100
39132.12001.P2	MG42682	Grigio	Plastica	Con paracolpo	100
39132.12000.F1	MG42683	Bianco	Plastica	Con magnete	100
39132.12001.F1	MG42684	Bianco	Plastica	Con paracolpo	100

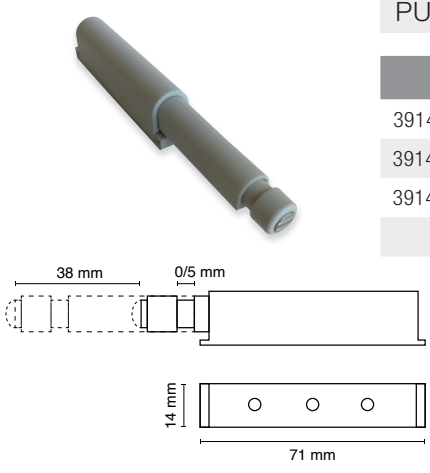
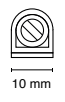

**PUSH TO OPEN MAXI**

CODICE	COD. BREVE	FINITURA	MAT.	DESCRIZIONE	BOX PZ.
39143.12000.F1	MG44252	Bianco	Plastica	con calamita	100
39143.12000.P2	MG44253	Grigio	Plastica	con calamita	100
39143.12000.83	MG44254	Antracite	Plastica	con calamita	100

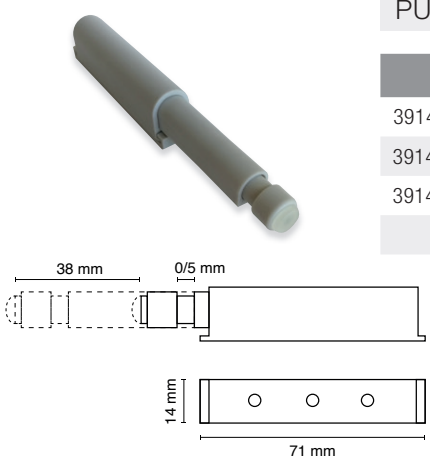

**PUSH TO OPEN MAXI**

CODICE	COD. BREVE	FINITURA	MAT.	DESCRIZIONE	BOX PZ.
39143.12001.F1	MG44255	Bianco	Plastica	con paracolpo	100
39143.12001.P2	MG44256	Grigio	Plastica	con paracolpo	100
39143.12001.83	MG44257	Antracite	Plastica	con paracolpo	100

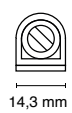

**CATENACCIO**

CODICE	COD. BREVE	FINITURA	MAT.	INGOMBRO MM	BOX PZ.
46006.08000.03	MG11458	Ottone Antico	Ferro	80x40	50
46006.08000.05	MG11459	Nero	Ferro	80x40	50
46006.08000.27	MG11461	Ferro Vecchio	Ferro	80x40	50



**CATENACCIOLIO SUPER**

CODICE	COD. BREVE	FINITURA	MAT.	INGOMBRO MM	BOX PZ.
46005.07000.64	MG11457	Tropicalizzato	Ferro	70	50
46005.07000.04	MG43592	Bronzato	ferro	70	50



## SERRATURA REDOSSO

CODICE	COD. BREVE	FINITURA	MAT.	INGOMBRO MM	BOX PZ.
39013.02000.27	MG37563	Ferro Vecchio	Ferro	20	12
39013.02000.05	MG9153	Nero	Ferro	20	12
39013.02500.27	MG37564	Ferro Vecchio	Ferro	25	12
39013.02500.05	MG9156	Nero	Ferro	25	12

## SERRATURA REDOSSO

CODICE	COD. BREVE	FINITURA	MAT.	INGOMBRO MM	BOX PZ.
39039Z015D0.04	MG9527	Bronzato	Ferro + Zama	15 DX	25
39039Z020D0.04	MG9531	Bronzato	Ferro + Zama	20 DX	25
39039Z025D0.04	MG9537	Bronzato	Ferro + Zama	25 DX	25
39039Z030D0.04	MG9539	Bronzato	Ferro + Zama	30 DX	25
39039Z015S0.04	MG9529	Bronzato	Ferro + Zama	15 SX	25
39039Z020S0.04	MG9534	Bronzato	Ferro + Zama	20 SX	25
39039Z025S0.04	MG9538	Bronzato	Ferro + Zama	25 SX	25
39039Z030S0.04	MG9541	Bronzato	Ferro + Zama	30 SX	25
39039Z015D0.17	MG42915	Ottonato	Ferro + Zama	15 DX	25
39039Z020D0.17	MG42916	Ottonato	Ferro + Zama	20 DX	25
39039Z025D0.17	MG42917	Ottonato	Ferro + Zama	25 DX	25
39039Z030D0.17	MG42918	Ottonato	Ferro + Zama	30 DX	25
39039Z015S0.17	MG42919	Ottonato	Ferro + Zama	15 SX	25
39039Z020S0.17	MG42920	Ottonato	Ferro + Zama	20 SX	25
39039Z025S0.17	MG42921	Ottonato	Ferro + Zama	25 SX	25
39039Z030S0.17	MG42922	Ottonato	Ferro + Zama	30 SX	25
39039Z015D0.32	MG42923	Nichelato	Ferro + Zama	15 DX	25
39039Z020D0.32	MG42924	Nichelato	Ferro + Zama	20 DX	25
39039Z025D0.32	MG42925	Nichelato	Ferro + Zama	25 DX	25
39039Z030D0.32	MG42926	Nichelato	Ferro + Zama	30 DX	25
39039Z015S0.32	MG42927	Nichelato	Ferro + Zama	15 SX	25
39039Z020S0.32	MG42928	Nichelato	Ferro + Zama	20 SX	25
39039Z025S0.32	MG42929	Nichelato	Ferro + Zama	25 SX	25
39039Z030S0.32	MG42930	Nichelato	Ferro + Zama	30 SX	25



## SERRATURA AD ASTE

CODICE	COD. BREVE	FINITURA	MAT.	INGOMBRO MM	BOX PZ.
39040.01500.04	MG9543	Bronzato	Ferro + Zama	15 DX-SX	10
39040.020D0.04	MG42934	Bronzato	Ferro + Zama	20 DX	10
39040.020S0.04	MG42935	Bronzato	Ferro + Zama	20 SX	10
39040.01500.17	MG9545	Ottonato	Ferro + Zama	15 DX-SX	10
39040.020D0.17	MG42936	Ottonato	Ferro + Zama	20 DX	10
39040.020S0.17	MG42937	Ottonato	Ferro + Zama	20 SX	10
39040.01500.32	MG42938	Nichelato	Ferro + Zama	15 DX-SX	10
39040.020D0.32	MG42939	Nichelato	Ferro + Zama	20 DX	10
39040.020S0.32	MG42940	Nichelato	Ferro + Zama	20 SX	10



ASTA PER SERRATURA

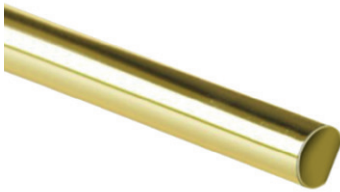

CODICE	COD. BREVE	FINITURA	MAT.	INGOMBRO MM	BOX PZ.
39027.00800.04	MG42952	Bronzato	Ferro	80	10
39027.01000.04	MG9481	Bronzato	Ferro	100	10
39027.01200.04	MG9487	Bronzato	Ferro	120	10
39027.01400.04	MG32517	Bronzato	Ferro	140	10
39027.00800.17	MG42953	Ottonato	Ferro	80	10
39027.01000.17	MG9482	Ottonato	Ferro	100	10
39027.01200.17	MG9488	Ottonato	Ferro	120	10
39027.01400.17	MG42954	Ottonato	Ferro	140	10
39027.00800.32	MG42955	Nichelato	Ferro	80	10
39027.01000.32	MG42956	Nichelato	Ferro	100	10
39027.01200.32	MG35923	Nichelato	Ferro	120	10
39027.01400.32	MG42957	Nichelato	Ferro	140	10

ACCESSORI PER SERRATURE 39040



sacchetto accessori

CODICE	COD. BREVE	FINITURA	MAT.	BOX PZ.
50076.00000.04	MG42942	Bronzato	Ferro	10
50076.00000.17	MG42943	Ottonato	Ferro	10
50076.00000.32	MG42944	Nichelato	Ferro	10

TAVELLINO

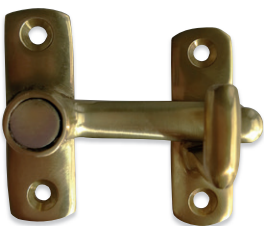

CODICE	COD. BREVE	FINITURA	MAT.	INGOMBRO MM	BOX PZ.
50081.00500.10	MG44287	Ottone	Ottone	mm 5	50
50081.00500.04	MG44288	Bronzato	Ottone	mm 5	50
50081.01800.10	MG44289	Ottone	Ottone	mm 18	50
50081.01800.04	MG44290	Bronzato	Ottone	mm 18	50

GANCIO FERMAPERSIANE



CODICE	COD. BREVE	FINITURA	MAT.	INGOMBRO MM	BOX PZ.
50082.06000.10	MG44291	Ottone	Ottone	mm 60	25
50082.06000.04	MG44292	Bronzato	Ottone	mm 60	25
50082.08000.10	MG44293	Ottone	Ottone	mm 80	25
50082.08000.04	MG44294	Bronzato	Ottone	mm 80	25
50082.10000.10	MG44295	Ottone	Ottone	mm 100	25
50082.10000.04	MG44296	Bronzato	Ottone	mm 100	25

**ASTA SNODATA**

CODICE	COD. BREVE	FINITURA	MAT.	INGOMBRO MM	BOX PZ.
49163.15000.64	MG43051	Tropicalizzato	Ferro	150 mm - Spess. 1,6 mm	25
49163.20000.64	MG43052	Tropicalizzato	Ferro	200 mm - Spess. 1,6 mm	25
49163.25000.64	MG43053	Tropicalizzato	Ferro	250 mm - Spess. 1,6 mm	25
49163.30000.64	MG43054	Tropicalizzato	Ferro	300 mm - Spess. 1,6 mm	25
49163.15000.32	MG43055	Nichelato	Ferro	150 mm - Spess. 1,6 mm	25
49163.20000.32	MG43056	Nichelato	Ferro	200 mm - Spess. 1,6 mm	25
49163.25000.32	MG43057	Nichelato	Ferro	250 mm - Spess. 1,6 mm	25
49163.30000.32	MG43058	Nichelato	Ferro	300 mm - Spess. 1,6 mm	25

**ASTA SNODATA C/FERMO**

CODICE	COD. BREVE	FINITURA	MAT.	INGOMBRO MM	BOX PZ.
49164.100D0.17	MG43059	Ottonato	Ferro	100 mm - DX - Spess. 1,6 mm	25
49164.150D0.17	MG43060	Ottonato	Ferro	150 mm - DX - Spess. 1,6 mm	25
49164.200D0.17	MG43061	Ottonato	Ferro	200 mm - DX - Spess. 1,6 mm	25
49164.250D0.17	MG43062	Ottonato	Ferro	250 mm - DX - Spess. 1,6 mm	25
49164.300D0.17	MG43063	Ottonato	Ferro	300 mm - DX - Spess. 1,6 mm	25
49164.100S0.17	MG43064	Ottonato	Ferro	100 mm - SX - Spess. 1,6 mm	25
49164.150S0.17	MG43065	Ottonato	Ferro	150 mm - SX - Spess. 1,6 mm	25
49164.200S0.17	MG43066	Ottonato	Ferro	200 mm - SX - Spess. 1,6 mm	25
49164.250S0.17	MG43067	Ottonato	Ferro	250 mm - SX - Spess. 1,6 mm	25
49164.300S0.17	MG43068	Ottonato	Ferro	300 mm - SX - Spess. 1,6 mm	25
49164.100D0.32	MG43069	Nichelato	Ferro	100 mm - DX - Spess. 1,6 mm	25
49164.150D0.32	MG43070	Nichelato	Ferro	150 mm - DX - Spess. 1,6 mm	25
49164.200D0.32	MG43071	Nichelato	Ferro	200 mm - DX - Spess. 1,6 mm	25
49164.250D0.32	MG43072	Nichelato	Ferro	250 mm - DX - Spess. 1,6 mm	25
49164.300D0.32	MG43073	Nichelato	Ferro	300 mm - DX - Spess. 1,6 mm	25
49164.100S0.32	MG43074	Nichelato	Ferro	100 mm - SX - Spess. 1,6 mm	25
49164.150S0.32	MG43075	Nichelato	Ferro	150 mm - SX - Spess. 1,6 mm	25
49164.200S0.32	MG43076	Nichelato	Ferro	200 mm - SX - Spess. 1,6 mm	25
49164.250S0.32	MG43077	Nichelato	Ferro	250 mm - SX - Spess. 1,6 mm	25
49164.300S0.32	MG43078	Nichelato	Ferro	300 mm - SX - Spess. 1,6 mm	25

**SNODO AD ASTA TONDA**

CODICE	COD. BREVE	FINITURA	MAT.	INGOMBRO MM	BOX PZ.
49020.01500.04	MG43079	Bronzata	Ferro	150 mm	25
49020.02000.04	MG43080	Bronzata	Ferro	200 mm	25
49020.02500.04	MG43081	Bronzata	Ferro	250 mm	25
49020.03000.04	MG43082	Bronzata	Ferro	300 mm	25
49020.01500.17	MG43083	Tropicalizzato	Ferro	150 mm	25
49020.02000.17	MG43084	Tropicalizzato	Ferro	200 mm	25
49020.02500.17	MG12370	Tropicalizzato	Ferro	250 mm	25
49020.03000.17	MG43085	Tropicalizzato	Ferro	300 mm	25
49020.01500.32	MG43086	Nichelato	Ferro	150 mm	25
49020.02000.32	MG43087	Nichelato	Ferro	200 mm	25
49020.02500.32	MG43088	Nichelato	Ferro	250 mm	25
49020.03000.32	MG43089	Nichelato	Ferro	300 mm	25





CHIUSURA PER TAVOLO C/INCONTRO

CODICE	COD. BREVE	FINITURA	MAT.	INGOMBRO MM	BOX PZ.
39134.03500.33	MG43090	Zincata	Ferro	35	25



CHIUSURA PER TAVOLO C/INCONTRO

CODICE	COD. BREVE	FINITURA	MAT.	INGOMBRO MM	BOX PZ.
39135.03300.33	MG43091	Zincata	Ferro	33,5	50

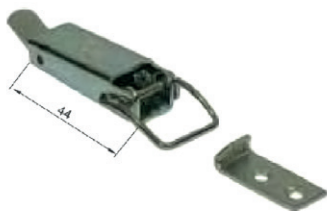

CHIUSURA PER TAVOLO C/INCONTRO

CODICE	COD. BREVE	FINITURA	MAT.	INGOMBRO MM	BOX PZ.
39028.10000.33C	MG9495	Zincata	Ferro	44	50



CHIUSURA PER TAVOLO C/INCONTRO

CODICE	COD. BREVE	FINITURA	MAT.	INGOMBRO MM	BOX PZ.
39136.04900.33	MG43092	Zincata	Ferro	49	50

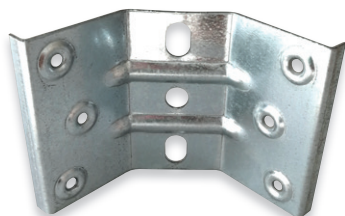

PIASTRA PER TAVOLO

CODICE	COD. BREVE	FINITURA	MAT.	INGOMBRO MM	BOX PZ.
41023.13300.33	MG10216	Zincata	Ferro	134 x H 92 mm	20

**NEW** FONDELLO 4 PUNTE



CODICE	COD. BREVE	FINITURA	MAT.	INGOMBRO MM	BOX PZ.
65028.00600.33	MG45687	Zincato	Ferro	Fondello 4 punte M6 18X10	200
65028.00800.33	MG45685	Zincato	Ferro	Fondello 4 punte M8 22X10	200
65028.01000.33	MG45686	Zincato	Ferro	Fondello 4 punte M10 25X12	200



PASSACAVO

CODICE	COD. BREVE	FINITURA	MAT.	INGOMBRO MM	BOX PZ.
49007.06000.P1	MG12334	Nero	Plastica	Diam. 60 mm	20
49007.06000.P2	MG43093	Grigio	Plastica	Diam. 60 mm	20
49007.06000.G1	MG43094	Marrone	Plastica	Diam. 60 mm	20
49007.06000.F1	MG12333	Bianco	Plastica	Diam. 60 mm	20

## PIEDE CILINDRICO IN ACCIAIO



CODICE	COD. BREVE	FINITURA	MAT.	INGOMBRO	BOX PZ.
53152.10000.F1	MG42685	Bianco	Ferro	D.30 H.100	20
53152.15000.F1	MG42686	Bianco	Ferro	D.30 H.150	20
53152.20000.F1	MG42687	Bianco	Ferro	D.30 H.200	20
53152.25000.F1	MG42688	Bianco	Ferro	D.30 H.250	20
53152.30000.F1	MG42689	Bianco	Ferro	D.30 H.300	20
53152.35000.F1	MG42690	Bianco	Ferro	D.30 H.350	20
53152.40000.F1	MG42691	Bianco	Ferro	D.30 H.400	20
53152.70000.F1	MG42692	Bianco	Ferro	D.30 H.700	20
53152.80000.F1	MG42693	Bianco	Ferro	D.30 H.800	20
53152.10000.P1	MG42694	Nero	Ferro	D.30 H.100	20
53152.15000.P1	MG42695	Nero	Ferro	D.30 H.150	20
53152.20000.P1	MG42696	Nero	Ferro	D.30 H.200	20
53152.25000.P1	MG42697	Nero	Ferro	D.30 H.250	20
53152.30000.P1	MG42698	Nero	Ferro	D.30 H.300	20
53152.35000.P1	MG42699	Nero	Ferro	D.30 H.350	20
53152.40000.P1	MG42700	Nero	Ferro	D.30 H.400	20
53152.70000.P1	MG42701	Nero	Ferro	D.30 H.700	20
53152.80000.P1	MG42702	Nero	Ferro	D.30 H.800	20

## PIEDE QUADRATO IN ACCIAIO



CODICE	COD. BREVE	FINITURA	MAT.	INGOMBRO MM	BOX PZ.
53153.10000.F1	MG42703	Bianco	Ferro	25x25 H.100	20
53153.15000.F1	MG42704	Bianco	Ferro	25x25 H.150	20
53153.20000.F1	MG42705	Bianco	Ferro	25x25 H.200	20
53153.25000.F1	MG42706	Bianco	Ferro	25x25 H.250	20
53153.30000.F1	MG42707	Bianco	Ferro	25x25 H.300	20
53153.35000.F1	MG42708	Bianco	Ferro	25x25 H.350	20
53153.40000.F1	MG42709	Bianco	Ferro	25x25 H.400	20
53153.70000.F1	MG42710	Bianco	Ferro	25x25 H.700	20
53153.80000.F1	MG42711	Bianco	Ferro	25x25 H.800	20
53153.10000.P1	MG42712	Nero	Ferro	25x25 H.100	20
53153.15000.P1	MG42713	Nero	Ferro	25x25 H.150	20
53153.20000.P1	MG42714	Nero	Ferro	25x25 H.200	20
53153.25000.P1	MG42715	Nero	Ferro	25x25 H.250	20
53153.30000.P1	MG42716	Nero	Ferro	25x25 H.300	20
53153.35000.P1	MG42717	Nero	Ferro	25x25 H.350	20
53153.40000.P1	MG42718	Nero	Ferro	25x25 H.400	20
53153.70000.P1	MG42719	Nero	Ferro	25x25 H.700	20
53153.80000.P1	MG42720	Nero	Ferro	25x25 H.800	20

## SOLO PIEDINO REGOLABILE PER PIEDE CILINDRICO E QUADRATO



CODICE	COD. BREVE	FINITURA	MAT.	INGOMBRO MM	BOX PZ.
53153.00000.P1	MG42722	Nero	Ferro	25x25	20

articoli in  
**LEGNO**



## CORNICE SCOLPITA IN LEGNO



CODICE	COD. BREVE	FINITURA	MAT.	INGOMBRO MM	BOX MT
55176.02600.00	MG43424	Naturale	Legno massiccio	26 x 13 mm - lungh. 2,44 mt	2,44

## CORNICE SCOLPITA IN LEGNO



CODICE	COD. BREVE	FINITURA	MAT.	INGOMBRO MM	BOX MT
55042.01900.00	MG43425	Naturale	Legno massiccio	19 x 12 mm - lungh. 2,44 mt	2,44
55042.02200.00	MG42091	Naturale	Legno massiccio	22 x 15 mm - lungh. 2,44 mt	2,44
55042.03000.00	MG42092	Naturale	Legno massiccio	30 x 20 mm - lungh. 2,44 mt	2,44
55042.03700.00	MG42093	Naturale	Legno massiccio	37 x 22 mm - lungh. 2,44 mt	2,44

## CORNICE SCOLPITA IN LEGNO



CODICE	COD. BREVE	FINITURA	MAT.	INGOMBRO MM	BOX MT
55166.01600.00	MG43428	Naturale	Legno massiccio	16 x 9 mm - lungh. 2,44 mt	2,44
55166.02300.00	MG42086	Naturale	Legno massiccio	23 x 13 mm - lungh. 2,44 mt	2,44
55166.03300.00	MG42087	Naturale	Legno massiccio	33 x 20 mm - lungh. 2,44 mt	2,44
55166.04000.00	MG42088	Naturale	Legno massiccio	40 x 21 mm - lungh. 2,44 mt	2,44

## CORNICE SCOLPITA IN LEGNO



CODICE	COD. BREVE	FINITURA	MAT.	INGOMBRO MM	BOX MT
55039.00800.00	MG42082	Naturale	Legno massiccio	Ø 8 mm - lungh. 2,40 mt	2,40
55039.01100.00	MG42083	Naturale	Legno massiccio	Ø 11 mm - lungh. 2,40 mt	2,40
55039.01700.00	MG42084	Naturale	Legno massiccio	Ø 17 mm - lungh. 2,40 mt	2,40
55039.01900.00	MG42085	Naturale	Legno massiccio	Ø 19 mm - lungh. 2,40 mt	2,40

## CORNICE SCOLPITA IN LEGNO



CODICE	COD. BREVE	FINITURA	MAT.	INGOMBRO MM	BOX MT
55038.00500.00	MG12897	Naturale	Legno massiccio	Ø 5 mm - lungh. 1 mt	20
55038.00700.00	MG12898	Naturale	Legno massiccio	Ø 7 mm - lungh. 1 mt	20
55038.00800.00	MG12899	Naturale	Legno massiccio	Ø 8 mm - lungh. 1 mt	20
55038.01200.00	MG12900	Naturale	Legno massiccio	Ø 12 mm - lungh. 1 mt	20

## CORNICE SCOLPITA IN LEGNO



CODICE	COD. BREVE	FINITURA	MAT.	INGOMBRO MM	BOX MT
55044.01300.00	MG12911	Naturale	Legno massiccio	13 x 9 mm - lungh. 2,44 mt	2,44
55044.01700.00	MG42089	Naturale	Legno massiccio	17 x 10 mm - lungh. 2,44 mt	2,44
55044.02300.00	MG42099	Naturale	Legno massiccio	23 x 13 mm - lungh. 2,44 mt	2,44



## PALO IN LEGNO

CODICE	COD. BREVE	FINITURA	MAT.	INGOMBRO MM	BOX PZ.
42006.C0901.00	MG43414	Naturale	Ayous	28x900	10
42006.C1001.00	MG43415	Naturale	Ayous	28x1000	10
42006.C1101.00	MG42461	Naturale	Ayous	28x1100	10
42006.C1201.00	MG43416	Naturale	Ayous	28x1200	10
42006.C1301.00	MG43417	Naturale	Ayous	28x1300	10
42006.C1401.00	MG43418	Naturale	Ayous	28x1400	10
42006.C1501.00	MG43419	Naturale	Ayous	28x1500	10
42006.C3001.00	MG42848	Naturale	Ayous	28x3000	10
42006.C1002.00	MG43420	Naturale	Tiglio 1° scelta	28x1000	10
42006.C1202.00	MG43421	Naturale	Tiglio 1° scelta	28x1200	10
42006.C3002.00	MG43422	Naturale	Tiglio 1° scelta	28x3000	10



## REGGIPALO LATERALE CHIUSO

CODICE	COD. BREVE	FINITURA	MAT.	INGOMBRO MM	BOX PZ.
42025.07600.00	MG10337	Naturale	Faggio	52x76	10



## REGGIPALO CENTRALE APERTO

CODICE	COD. BREVE	FINITURA	MAT.	INGOMBRO MM	BOX PZ.
42020.07600.00	MG10319	Naturale	Faggio	52x76	10



## REGGIPALO LATERALE QUADRO

CODICE	COD. BREVE	FINITURA	MAT.	INGOMBRO MM	BOX PZ.
42024.08000.00	MG10335	Naturale	Ayous	80x60	10



## REGGIPALO LATERALE TONDO

CODICE	COD. BREVE	FINITURA	MAT.	INGOMBRO MM	BOX PZ.
42015.03000.00	MG10312	Naturale	Faggio	30x50	10

**REGGIPIANI**

CODICE	COD. BREVE	FINITURA	MAT.	INGOMBRO MM	BOX PZ.
42003.C3102.00	MG43455	Naturale	Tiglio	*20x11x3100	10

**LAMELLO IN LEGNO**

CODICE	COD. BREVE	FINITURA	MAT.	INGOMBRO MM	BOX PZ.
41027.02000.00	MG10223	Naturale	Legno	56x23	20
41027.01000.00	MG10222	Naturale	Legno	55x20	10

**SPINA IN LEGNO EUCALIPTO - 1 KG**

CODICE	COD. BREVE	FINITURA	MAT.	INGOMBRO MM	BOX
41015.0300E.00	MG44724	Naturale	Eucalipto	Ø6x30	1 kg
41016.0300E.00	MG44725	Naturale	Eucalipto	Ø8x30	1 kg
41016.0350E.00	MG44726	Naturale	Eucalipto	Ø8x35	1 kg
41016.0400E.00	MG44727	Naturale	Eucalipto	Ø8x40	1 kg
41017.0300E.00	MG44728	Naturale	Eucalipto	Ø10x30	1 kg
41017.0400E.00	MG44729	Naturale	Eucalipto	Ø10x40	1 kg

**SPINA IN LEGNO FAGGIO - 1 KG**

CODICE	COD. BREVE	FINITURA	MAT.	INGOMBRO MM	BOX
41015.03000.00	MG10183	Naturale	Faggio	Ø6x30	1 kg
41015.03500.00	MG10184	Naturale	Faggio	Ø6x35	1 kg
41015.04000.00	MG10185	Naturale	Faggio	Ø6x40	1 kg
41016.02500.00	MG10186	Naturale	Faggio	Ø8x25	1 kg
41016.03000.00	MG10187	Naturale	Faggio	Ø8x30	1 kg
41016.03500.00	MG10188	Naturale	Faggio	Ø8x35	1 kg
41016.04000.00	MG10189	Naturale	Faggio	Ø8x40	1 kg
41017.03000.00	MG10191	Naturale	Faggio	Ø10x30	1 kg
41017.03500.00	MG10192	Naturale	Faggio	Ø10x35	1 kg
41017.04000.00	MG10193	Naturale	Faggio	Ø10x40	1 kg
41017.05000.00	MG10194	Naturale	Faggio	Ø10x50	1 kg

**SPINA LEGNO IN VERGA**

CODICE	COD. BREVE	FINITURA	MAT.	INGOMBRO MM	BOX PZ.
41018.00600.00	MG10195	Naturale	Legno	Ø6 x 1mt	50
41018.00800.00	MG10196	Naturale	Legno	Ø8 x 1mt	50
41018.01000.00	MG10197	Naturale	Legno	Ø10 x 1mt	50
41018.01200.00	MG10198	Naturale	Legno	Ø12 x 1mt	50
41018.01400.00	MG10199	Naturale	Legno	Ø14 x 1mt	50

ferramenta da  
**MOBILE e CUCINA**





**Fluidità e facilità. PB15 è il sistema ad ante rientranti Cinetto con rientro autonomo dell'anta. Grazie al sistema a parallelogrammi, l'anta rientra nella tasca con velocità e precisione.**

Può essere installato in pochi minuti in svariate applicazioni sui fianchi armadio da 1,6 a 2,8 metri. Supporta ante fino a 700x2800 mm con peso fino a 30 kg e con l'installazione delle comuni cerniere. Il set è completo di tutto: meccanismo premontato, guarnizione e tutta la ferramenta necessaria per ogni configurazione.

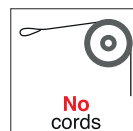
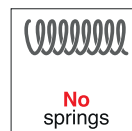
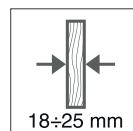
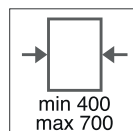
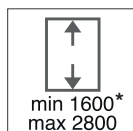
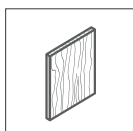
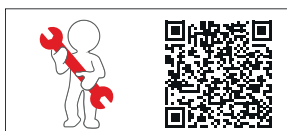

\*misura 1600-2000  
disponibile su richiesta

**NEW** SISTEMA SCORREVOLE PER ANTE RIENTRANTI - ANTA SINGOLA 30 KG

CODICE	COD. BREVE	INGOMBRO MM	DESCRIZIONE	BOX PZ.
PB15KT70000017	MG46129	2000-2400	Meccanismo Sinistro	1
PB15KT70000018	MG46130	2000-2400	Meccanismo Destro	1
PB15KT70000019	MG46127	2400-2800	Meccanismo Sinistro	1
PB15KT70000020	MG46128	2400-2800	Meccanismo Destro	1

**PB15** è compatibile con cerniere standard, ammortizzate, di diversi marchi facilmente reperibili sul mercato.

Caratteristiche della cerniera:

- collo 0
- angolo di apertura 110°
- sormonto, a discrezione del cliente
- limitatore di apertura

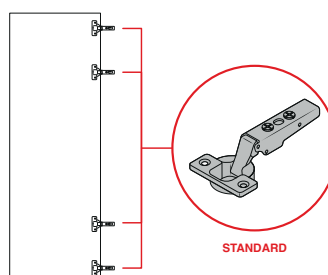



Grazie allo speciale sistema di apertura **Easy Opening**, le ante PB15 completano la loro apertura entrando nella tasca con una lieve spinta.

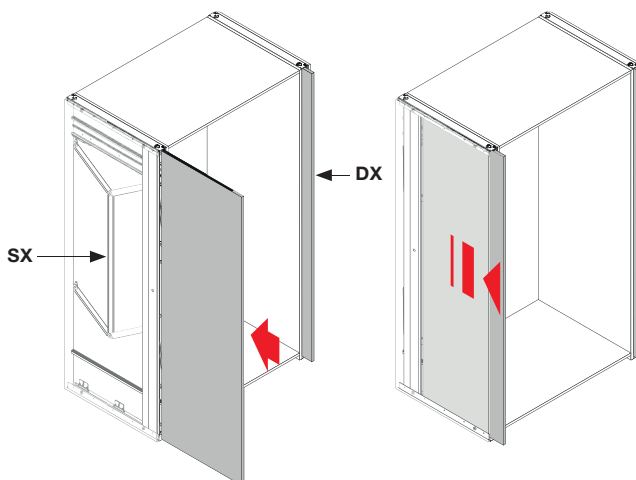

**Applicazioni porta**

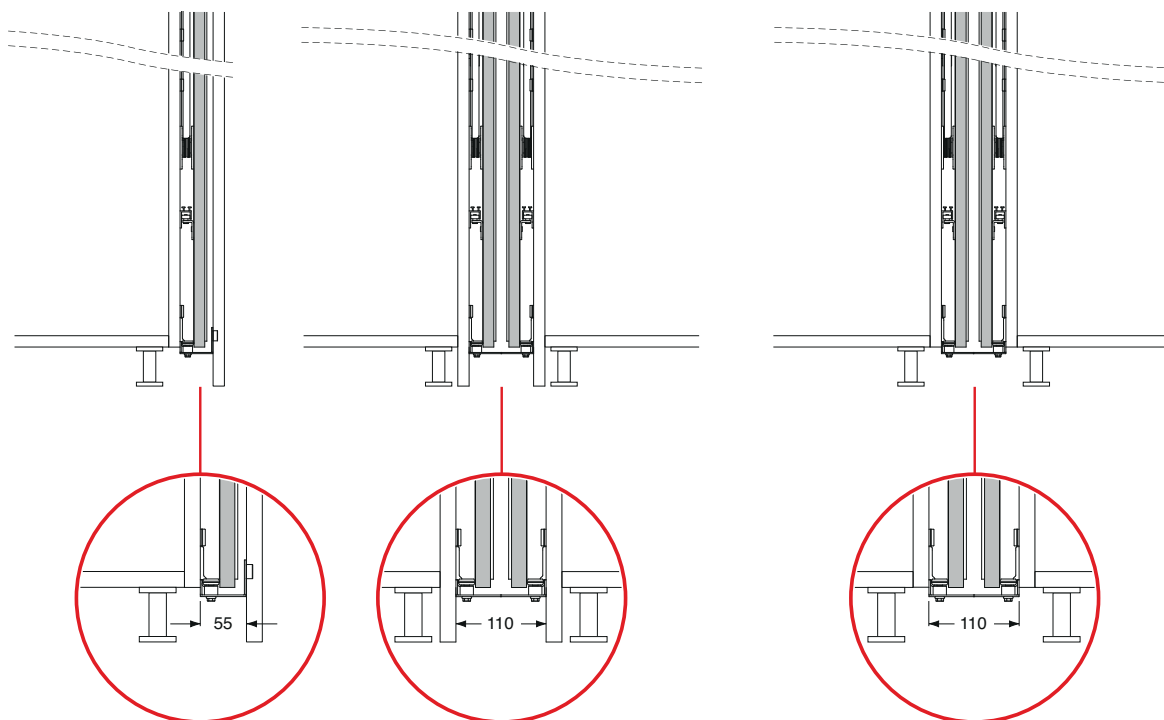

**OPZIONALE**

**NEW**

CONFEZIONE STAFFE DI UNIONE TRA FIANCHI PER ANTA DOPPIA

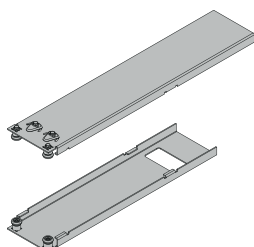

La confezione staffe di unione tra fianchi per anta doppia deve essere ordinata separatamente.

CODICE	COD. BREVE	MATERIALE	FINITURA	BOX PZ.
PB15KT7VN60001	MG46171	Ferro	Nero	1

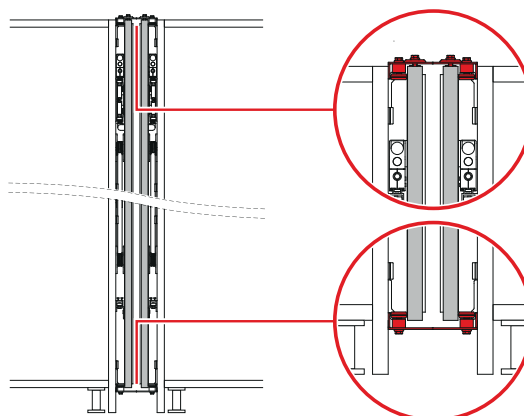



**REGGIPENSILE FISSAGGIO CON VITI**

CODICE	COD. BREVE	FINITURA	MAT.	INGOMBRO MM	BOX PZ.
42126.146S0.F1	MG42589	Bianco	Ferro + Plastica	SX	100
42126.146S0.G1	MG43095	Marrone	Ferro + Plastica	SX	100
42126.146D0.F1	MG42590	Bianco	Ferro + Plastica	DX	100
42126.146D0.G1	MG43096	Marrone	Ferro + Plastica	DX	100

**REGGIPENSILE CON CODOLI**

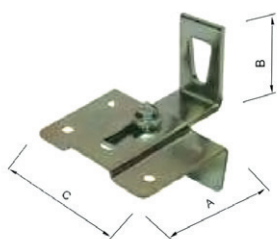
CODICE	COD. BREVE	FINITURA	MAT.	INGOMBRO MM	BOX PZ.
42127.000S0.F1	MG42737	Bianco	Ferro + Plastica	SX	100
42127.000D0.F1	MG42738	Bianco	Ferro + Plastica	DX	100

**ATTACCAGLIA REGOLABILE**

CODICE	COD. BREVE	FINITURA	MAT.	INGOMBRO MM	BOX PZ.
49015.08600.33	MG12363	Zincato	Ferro	SX - A 55 x B 48 x C 22	100

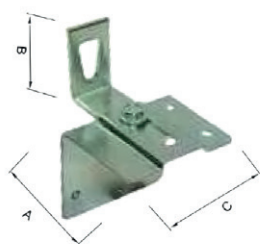
**ATTACCAGLIA REGOLABILE**

CODICE	COD. BREVE	FINITURA	MAT.	INGOMBRO MM	BOX PZ.
49016.04700.33	MG12364	Zincato	Ferro	SX - A 45 x B 47 x C 55	100

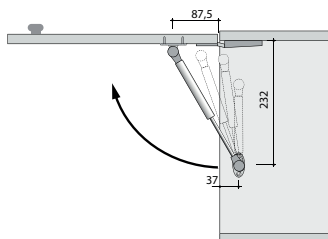
**PISTONE**

CODICE	COD. BREVE	FINITURA	MAT.	DESCRIZIONE	BOX PZ.
FPG004MG39950	MG39950	Grigio	Ferro e plastica	60 NW	25
FPG004MG39951	MG39951	Grigio	Ferro e plastica	80 NW	25
FPG004MG39952	MG39952	Grigio	Ferro e plastica	100 NW	25
FPG004MG39953	MG39953	Grigio	Ferro e plastica	120 NW	25
FPG004MG39995	MG39995	Grigio	Ferro e plastica	140 NW	25

**SNODO AMMORTIZZATO PER CUCINA**

CODICE	COD. BREVE	FINITURA	MAT.	BOX PZ.
44339.00000.32	MG44259	Cromato	ferro	10 CP

**SNODO VARIABILE PER CUCINA**

CODICE	COD. BREVE	FINITURA	MAT.	BOX PZ.
44340.00000.32	MG44260	Cromato	ferro	10

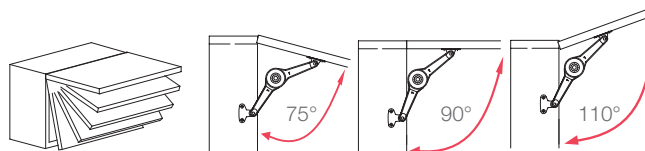



SCOLAPIATTI INOX CON CODOLI

CODICE	COD. BREVE	FINITURA	MAT.	INGOMBRO MM	BOX PZ.
SCOLA.600	MG44261	Cromato	Inox	600 mm	5
SCOLA.800	MG44262	Cromato	Inox	800 mm	5
SCOLA.900	MG44263	Cromato	Inox	900 mm	5

**NEW** ZOCCOLO IN ALLUMINIO

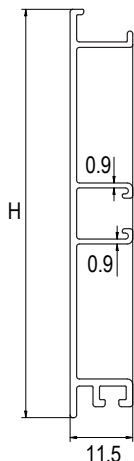

CODICE	COD. BREVE	FINITURA	MAT.	MISURE mm		BOX PZ.
				H	L	
53184.08000.00	MG46102	Alluminio spazzolato	Alluminio	80	4000	15
53184.08000.F1	MG46103	Bianco	Alluminio	80	4000	15
53184.08000.P1	MG46104	Nero	Alluminio	80	4000	15
53184.10000.00	MG46105	Alluminio spazzolato	Alluminio	100	4000	15
53184.10000.F1	MG46106	Bianco	Alluminio	100	4000	15
53184.10000.P1	MG46107	Nero	Alluminio	100	4000	15

**NEW** AGGANCIO PIEDEINO PER ZOCCOLO IN ALLUMINIO



CODICE	COD. BREVE	FINITURA	MAT.	BOX PZ.
49194.04000.P1	MG46134	Nero	Plastica	100

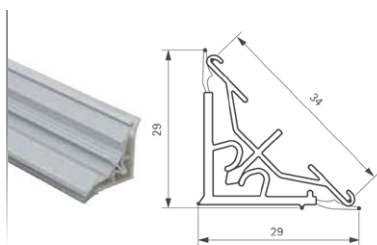
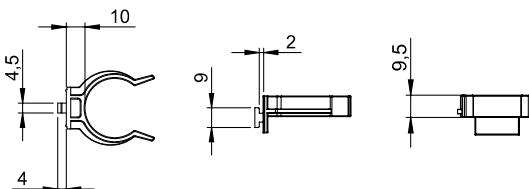

Alzatina PANNELLABILE 45°

Materiale: Alluminio/Plastica

**NEW**

CODICE	COD. BREVE	FINITURA	MISURE mm		BOX
			<----->	L	
5069.400.PL00D	MG44641	Alluminio anodizzato	29 x 29	4000	20

Kit accessori per alzatine triangolari

Materiale: plastica antiurto

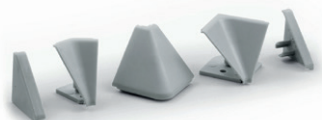

CODICE	COD. BREVE	FINITURA	BOX
51.09.565GR	MG38569	Grigio	1 kit

Zoccolo in **PLASTICA RIVESTITO OTTONE SATINATO**

Materiale: plastica

**NEW**

CODICE	COD. BREVE	FINITURA	MISURE mm		BOX
			H	L	
2090400.0524*	MG45706	Ottone Satinato	100	4000	15
2092400.0524*	MG45707	Ottone Satinato	120	4000	15
2095400.0524*	MG45708	Ottone Satinato	150	4000	12

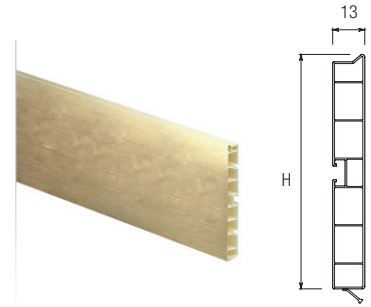

Angolo 90° per zoccoli in **PLASTICA RIVESTITO OTTONE SATINATO**

Materiale: plastica

**NEW**

CODICE	COD. BREVE	FINITURA	MISURE mm	BOX
			H	
21.19F5.0524	MG45709	Ottone Satinato	150	1

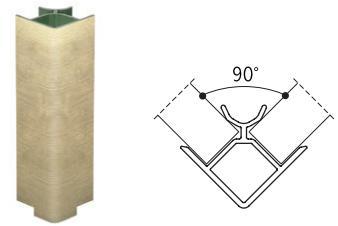

Alzatina triangolare 45°

Materiale: plastica

**NEW**

CODICE	COD. BREVE	FINITURA	MISURE mm		BOX
			<----->	L	
5066400PVC.0524*	MG45809	Ottone Satinato	29 x 29	4000	20

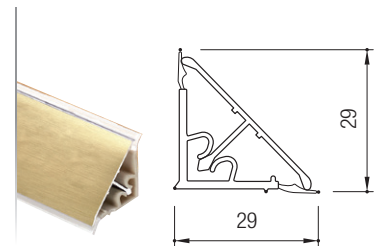

Kit accessori per alzatine triangolari (consigliato in abbinamento alla finitura Ottone Satinato)

Materiale: plastica antiurto

CODICE	COD. BREVE	FINITURA	BOX
51.09.565NR	MG40994	Nero	1 kit

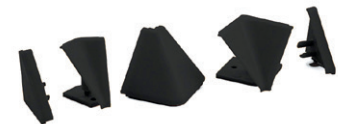

\* Per una condizione ottimale di trasporto, ordinare lotti da 10 pezzi a scelta tra gli articoli contrassegnati da asterisco.



Zoccolo in **PLASTICA RIVESTITO AVORIO**

Materiale: plastica

**NEW**

CODICE	COD. BREVE	FINITURA	MISURE mm		BOX
			H	L	
2090400.5075*	MG44974	Avorio	100	4000	15
2092400.5075*	MG46155	Avorio	120	4000	15
2095400.5075*	MG44984	Avorio	150	4000	12

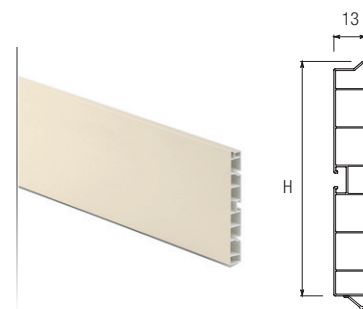

Angolo 90° per zoccoli in **PLASTICA RIVESTITO AVORIO**

Materiale: plastica

**NEW**

CODICE	COD. BREVE	FINITURA	MISURE mm	BOX
			H	
21.19F5.5075	MG44631	Avorio	150	1

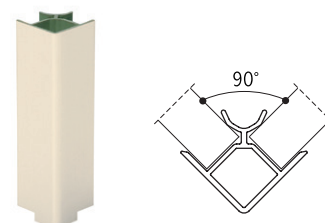

Alzatina triangolare 45°

Materiale: plastica

**NEW**

CODICE	COD. BREVE	FINITURA	MISURE mm		BOX
			<----->	L	
5066400PVC.5075*	MG44904	Avorio	29 x 29	4000	20

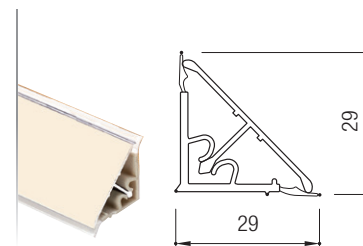

Kit accessori per alzatine triangolari

Materiale: plastica antiurto

**NEW**

CODICE	COD. BREVE	FINITURA	BOX
51.09.565AV	MG44905	Avorio	1 kit



KIT 4 PIEDINI CON 4 VITI PASSANTI E 2 GANCI



CODICE	COD. BREVE	FINITURA	MAT.	INGOMBRO MM	BOX PZ.
10.A2S17642	MG35913	Nero	Plastica	H100	1
10.A2S17742	MG35914	Nero	Plastica	H120	1
10.A2S18142	MG35915	Nero	Plastica	H150	1



Gancio magnetico per zoccolo

Materiale: Plastica e magnete

**NEW**

CODICE	COD. BREVE	BOX
10.06.502	MG45717	2

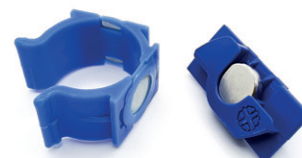

\* Per una condizione ottimale di trasporto, ordinare lotti da 10 pezzi a scelta tra gli articoli contrassegnati da asterisco.

Profilo gola sottotop

Materiale: alluminio

**NEW**

CODICE	COD. BREVE	FINITURA	MISURE mm L	BOX
49190.00000.00	MG46108	Alluminio spazzolato	4300	10
49190.00000.F1	MG46109	Bianco	4300	10
49190.00000.P1	MG46110	Nero spazzolato	4300	10

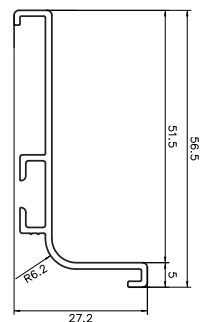

Profilo gola cassetto

Materiale: alluminio

**NEW**

CODICE	COD. BREVE	FINITURA	MISURE mm L	BOX
49191.00000.00	MG46111	Alluminio spazzolato	4300	10
49191.00000.F1	MG46112	Bianco	4300	10
49191.00000.P1	MG46113	Nero spazzolato	4300	10

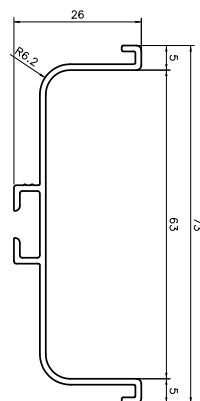

Profilo gola verticale singola

Materiale: alluminio

**NEW**

CODICE	COD. BREVE	FINITURA	MISURE mm L	BOX
49192.00000.00	MG46114	Alluminio spazzolato	4700	8
49192.00000.F1	MG46115	Bianco	4700	8
49192.00000.P1	MG46116	Nero spazzolato	4700	8

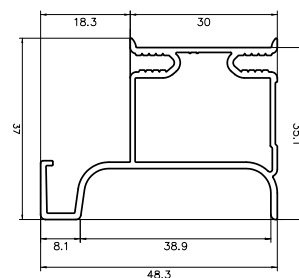

Profilo gola verticale doppia

Materiale: alluminio

**NEW**

CODICE	COD. BREVE	FINITURA	MISURE mm L	BOX
49193.00000.00	MG46117	Alluminio spazzolato	4700	6
49193.00000.F1	MG46118	Bianco	4700	6
49193.00000.P1	MG46119	Nero spazzolato	4700	6

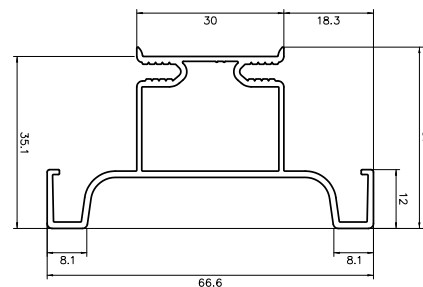

Set accessori fissaggio per profili gola

Materiale: ferro

CODICE	COD. BREVE	FINITURA	BOX
81.G1.1001	MG38571	grigio	1

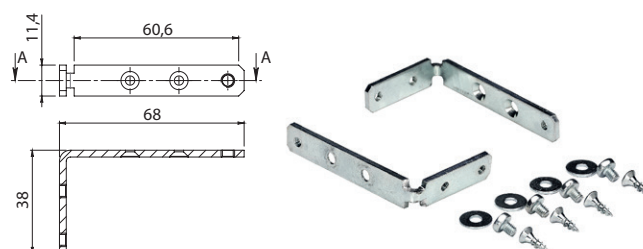

Guida a sfera estrazione totale NON ammortizzata h.45mm

Materiale: acciaio

**NEW**



CODICE	COD. BREVE	FINITURA	PORTATA kg	LUNGHEZZA mm	SPESSORE mm	BOX
52088.02500.33	MG45632	Zincato	30	250	1.0x1.0x1.2	15
52088.03000.33	MG45633	Zincato	30	300	1.0x1.0x1.2	15
52088.03500.33	MG45634	Zincato	30	350	1.0x1.0x1.2	15
52088.04000.33	MG45635	Zincato	30	400	1.0x1.0x1.2	15
52088.04500.33	MG45636	Zincato	30	450	1.0x1.0x1.2	15
52088.05000.33	MG45637	Zincato	30	500	1.0x1.0x1.2	15
52088.05500.33	MG45638	Zincato	30	550	1.0x1.0x1.2	15
52088.06000.33	MG45639	Zincato	30	600	1.0x1.0x1.2	15

Guida a sfera estrazione totale ammortizzata h.mm.45

Materiale: acciaio

**NEW**



CODICE	COD. BREVE	FINITURA	PORTATA kg	LUNGHEZZA mm	SPESSORE mm	BOX
52089.03000.33	MG45670	Zincato	45	300	1.2x1.2x1.2	15
52089.03500.33	MG45671	Zincato	45	350	1.2x1.2x1.2	15
52089.04000.33	MG45672	Zincato	45	400	1.2x1.2x1.2	15
52089.04500.33	MG45673	Zincato	45	450	1.2x1.2x1.2	15
52089.05000.33	MG45674	Zincato	45	500	1.2x1.2x1.2	15
52089.05500.33	MG45675	Zincato	45	550	1.2x1.2x1.2	15
52089.06000.33	MG45676	Zincato	45	600	1.2x1.2x1.2	15

**LATO FIANCO**

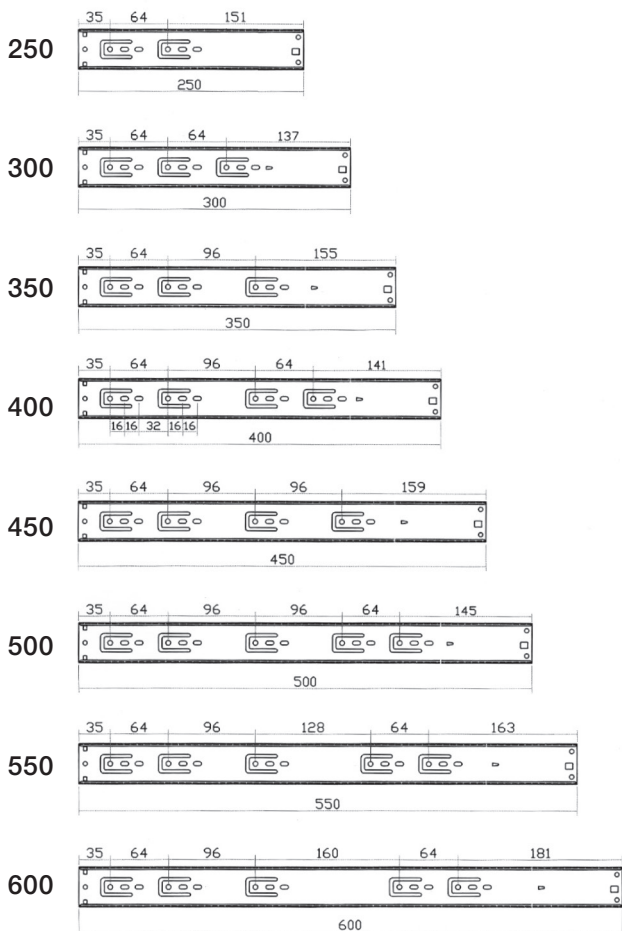

**LATO CASSETTO**

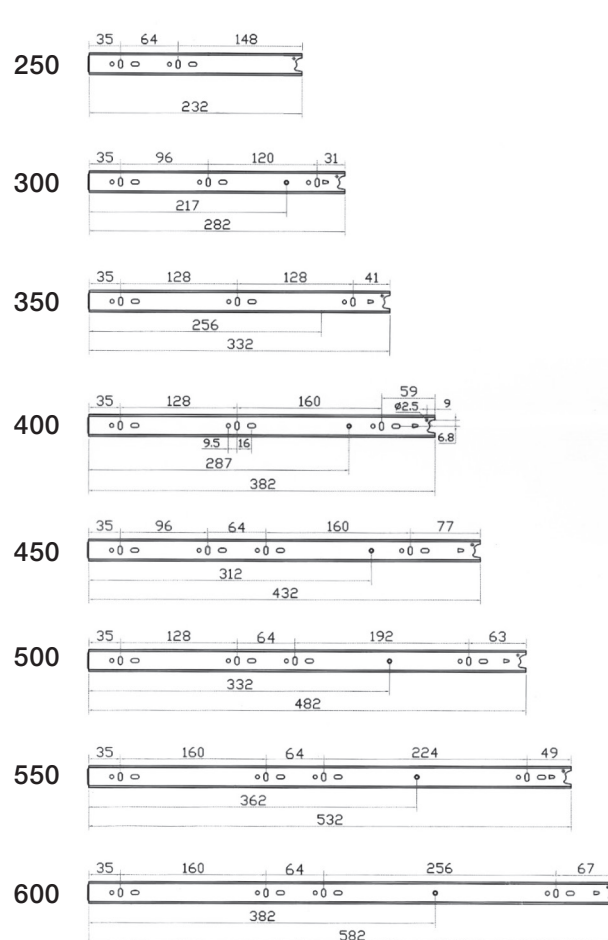

**Guida sottocassetto estrazione totale ammortizzata con maniglia 3D**

Materiale: acciaio

**NEW**

CODICE	COD. BREVE	FINITURA	PORTATA kg	LUNGHEZZA	BOX
52090.02500.33	MG45677	Zincato	30	250	10
52090.03000.33	MG45679	Zincato	30	300	10
52090.03500.33	MG45680	Zincato	30	350	10
52090.04000.33	MG45678	Zincato	30	400	10
52090.04500.33	MG45681	Zincato	30	450	10
52090.05000.33	MG45682	Zincato	30	500	10
52090.05500.33	MG45683	Zincato	30	550	10
52090.06000.33	MG45684	Zincato	30	600	10



**50.000 cicli**  
RAPPORTO DI PROVA 346531

**Installazione maniglia**

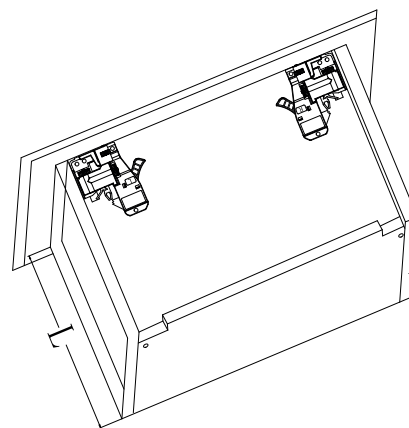

**Calcolo dello spazio interno del cassetto**

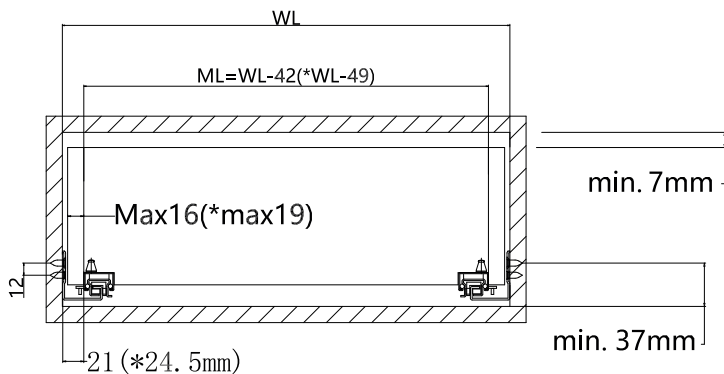

\* per cassetti spessore 19mm

**Riferimento foro gancio posteriore**

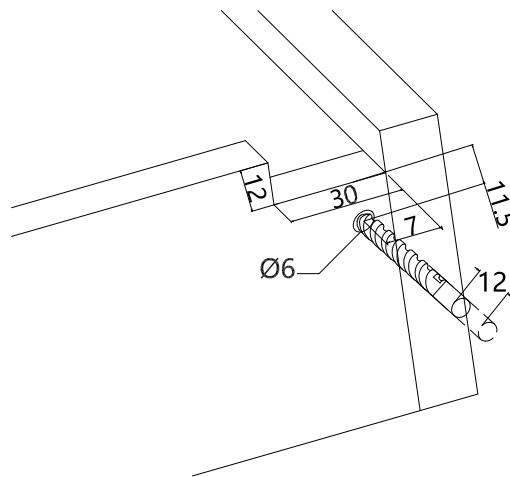

**Distanza tra i fori**

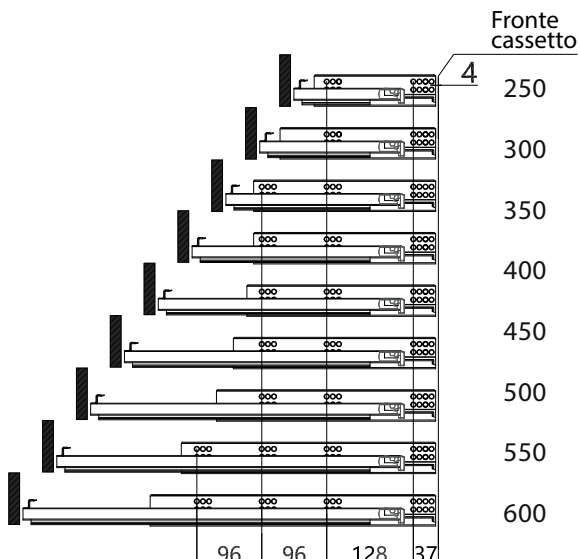

Lunghezza nominale	Lunghezza cassetto	Profondità interna	Profondità interna + X (spessore pannello)
250mm	240mm	260mm	260mm+X
300mm	290mm	310mm	310mm+X
350mm	340mm	360mm	360mm+X
400mm	390mm	410mm	410mm+X
450mm	440mm	460mm	460mm+X
500mm	490mm	510mm	510mm+X
550mm	540mm	560mm	560mm+X
600mm	590mm	610mm	610mm+X



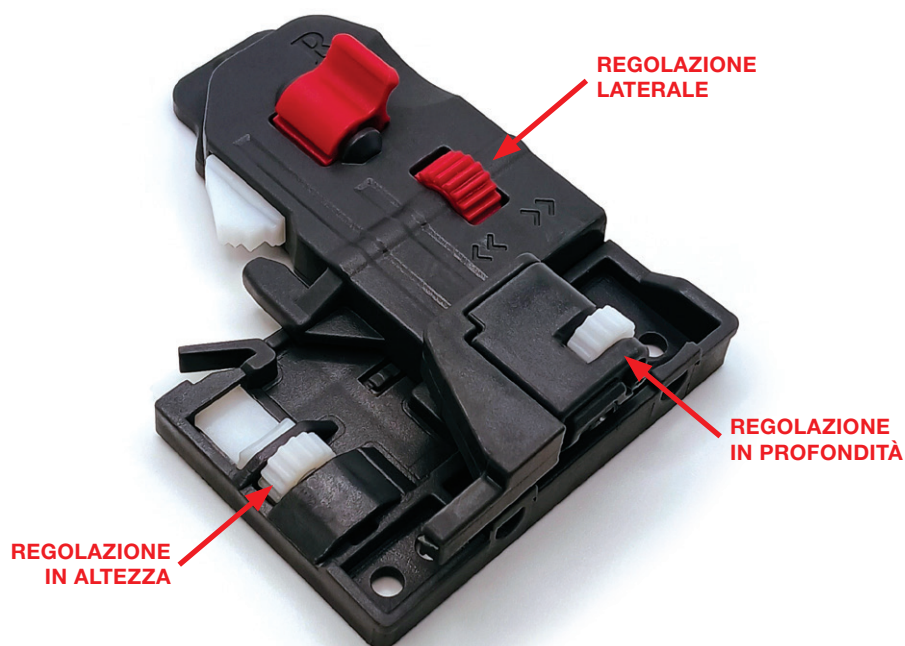

Cassetto

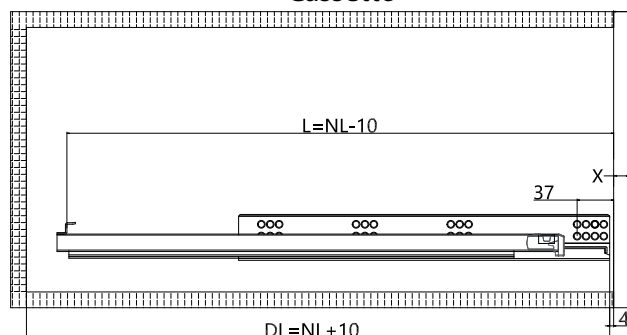

Cassetto interno

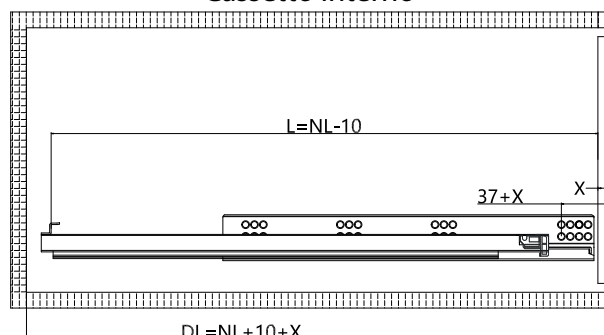

X: spessore pannello frontale  
L: lunghezza cassetto

WL: larghezza interna corpo  
NL: lunghezza nominale

DL: profondità interna corpo  
ML: larghezza utile del cassetto

**Guide a ruote**

Materiale: ferro

CODICE	COD. BREVE	COLORE	PORTATA kg	LUNGHEZZA	BOX
FPR002MG39934	MG39934	Bianco	25	250	25 cp
FPR002MG39935	MG39935	Bianco	25	300	25 cp
FPR002MG39936	MG39936	Bianco	25	350	25 cp
FPR002MG39937	MG39937	Bianco	25	400	25 cp
FPR002MG39938	MG39938	Bianco	25	450	25 cp
FPR002MG39939	MG39939	Bianco	25	500	25 cp
FPR002MG39940	MG39940	Bianco	25	550	25 cp
FPR002MG39941	MG39941	Bianco	25	600	25 cp
FPR002MG39942	MG39942	Marrone	25	250	25 cp
FPR002MG39943	MG39943	Marrone	25	300	25 cp
FPR002MG39944	MG39944	Marrone	25	350	25 cp
FPR002MG39945	MG39945	Marrone	25	400	25 cp
FPR002MG39946	MG39946	Marrone	25	450	25 cp
FPR002MG39947	MG39947	Marrone	25	500	25 cp
FPR002MG39948	MG39948	Marrone	25	550	25 cp
FPR002MG39949	MG39949	Marrone	25	600	25 cp



ferramenta per  
**ARMADI e LETTI**



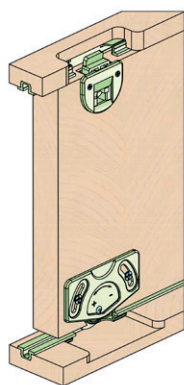

SCORREVOLE IN PLASTICA PER ANTINE 15 KG

CODICE	COD. BREVE	FINITURA	MAT.	INGOMBRO MM	DESCRIZIONE	BOX PZ.
52069.00000.G1	MG42591	Marrone	Plastica		Kit 1 porta	10
52069.00000.F1	MG42883	Bianco	Plastica		Kit 1 porta	10
52070.C2000.G1	MG42592	Marrone	Plastica	2000 mm	Canalina in plastica	10
52070.C2000.F1	MG42884	Bianco	Plastica	2000 mm	Canalina in plastica	10
52070.C3000.G1	MG42593	Marrone	Plastica	3000 mm	Canalina in plastica	10
52070.C3000.F1	MG42885	Bianco	Plastica	3000 mm	Canalina in plastica	10

SCORREVOLE IN ZAMA PER ANTE 50 KG

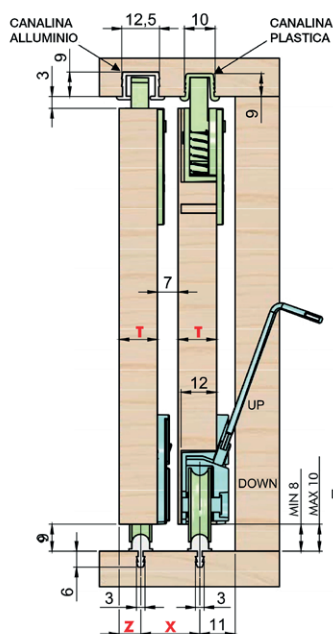

**NEW**  
**NEW**

CODICE	COD. BREVE	FINITURA	MAT.	INGOMBRO MM	DESCRIZIONE	BOX PZ.
52071.00000.04	MG42739	Bronzato/nero	Zama		Kit 1 porta	10
52071.00000.33	MG42886	Nichelato/bianco	Zama		Kit 1 porta	10
52072.C2000.G1	MG42740	Marrone	Plastica	2000 mm	Canalina superiore plastica	10
52072.C2000.F1	MG42887	Bianco	Plastica	2000 mm	Canalina superiore plastica	10
52072.C3000.G1	MG42741	Marrone	Plastica	3000 mm	Canalina superiore plastica	10
52072.C3000.F1	MG42888	Bianco	Plastica	3000 mm	Canalina superiore plastica	10
52093.C2000.00	MG46172	Anodizzato naturale	Alluminio	2000 mm	Binario superiore alluminio	10
52093.C3000.00	MG46173	Anodizzato naturale	Alluminio	3000 mm	Binario superiore alluminio	10
49162.C2000.04	MG42742	Bronzato	Alluminio	2000 mm	Binario inferiore alluminio	10
49162.C2000.00	MG42889	Anodizzato naturale	Alluminio	2000 mm	Binario inferiore alluminio	10
49162.C3000.04	MG42743	Bronzato	Alluminio	3000 mm	Binario inferiore alluminio	10
49162.C3000.00	MG42890	Anodizzato naturale	Alluminio	3000 mm	Binario inferiore alluminio	10

T	X	Z
16	23	10
18	25	12
20	27	14



RADDRIZZANTE (SET)

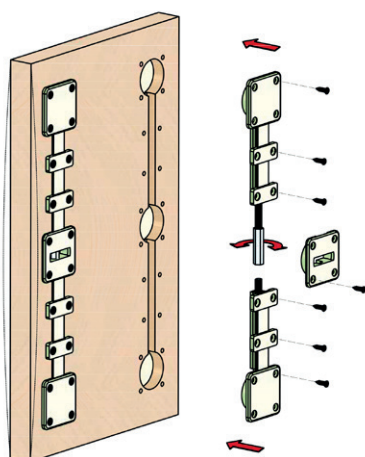

CODICE	COD. BREVE	FINITURA	MATERIALE	INGOMBRO MM	BOX PZ.
52068.C1850.G1	MG42586	Copertura marrone	Plastica e ferro	1850 mm	20
52068.C1850.F1	MG42891	Copertura bianca	Plastica e ferro	1850 mm	20
52068.C2050.G1	MG42587	Copertura marrone	Plastica e ferro	2050 mm	20
52068.C2050.F1	MG42892	Copertura bianca	Plastica e ferro	2050 mm	20
52068.C2250.G1	MG42588	Copertura marrone	Plastica e ferro	2250 mm	20
52068.C2250.F1	MG42893	Copertura bianca	Plastica e ferro	2250 mm	20

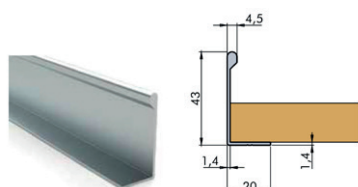

MANIGLIA IN ALLUMINIO PER ARMADIO

CODICE	COD. BREVE	FINITURA	MATERIALE	INGOMBRO MM	BOX PZ.
15ME.001300.00	MG42856	Anodizzato Naturale	Alluminio	H 3000 mm	10

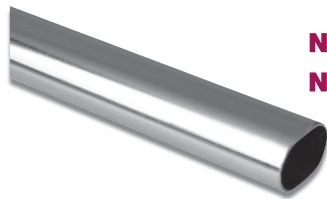
**NEW**  
**NEW**

## TUBO OVALE ARMADI

CODICE	COD. BREVE	FINITURA	MAT.	INGOMBRO MM	BOX PZ.
42055.C1002.32	MG45629	Cromato	Ferro	30x15 cm.100 - Spessore 0,6	10
42055.C3002.32	MG45630	Cromato	Ferro	30x15 cm.300 - Spessore 0,6	10
42055.C1001.32	MG42679	Cromato	Ferro	30x15 cm.100 - Spessore 0,75	10
42055.C1501.32	MG42680	Cromato	Ferro	30x15 cm.150 - Spessore 0,75	10
42055.C3001.32	MG30210	Cromato	Ferro	30x15 cm.300 - Spessore 0,75	10

**NEW**  
**NEW**  
**NEW**

## TUBO TONDO ARMADI

CODICE	COD. BREVE	FINITURA	MAT.	INGOMBRO MM	BOX PZ.
42008.C1000.32	MG43097	Cromato	Ferro	Ø18 cm.100 - Spessore 0,7	10
42008.C1500.32	MG43098	Cromato	Ferro	Ø18 cm.150 - Spessore 0,7	10
42008.C1025.32	MG43099	Cromato	Ferro	Ø25 cm.100 - Spessore 0,7	10
42008.C1525.32	MG43100	Cromato	Ferro	Ø25 cm.150 - Spessore 0,7	10
42008.C3000.32	MG39614	Cromato	Ferro	Ø18 cm.300 - Spessore 0,8	10
42008.C3025.32	MG43409	Cromato	Ferro	Ø25 cm.300 - Spessore 0,8	10
42008.C3030.32	MG45631	Cromato	Ferro	Ø30 cm.300 - Spessore 0,8	5



Bianco



Marrone

## TUBO TONDO ARMADI

CODICE	COD. BREVE	FINITURA	MAT.	INGOMBRO MM	BOX PZ.
42008.C1000.F1	MG43101	Bianco	Ferro Plasticato	Ø18 cm.100	10
42008.C1500.F1	MG43102	Bianco	Ferro Plasticato	Ø18 cm.150	10
42008.C1000.G1	MG43103	Marrone	Ferro Plasticato	Ø18 cm.100	10
42008.C1500.G1	MG43104	Marrone	Ferro Plasticato	Ø18 cm.150	10

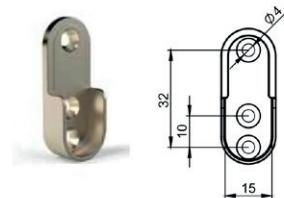

## REGGITUBO PER TUBO 30X15

CODICE	COD. BREVE	FINITURA	MAT.	INGOMBRO MM	BOX PZ.
42124Z03200.32	MG42322	Nichelato	Zama	32x15 i16	50



## REGGITUBO PER TUBO 30X15

CODICE	COD. BREVE	FINITURA	MAT.	INGOMBRO MM	BOX PZ.
42014Z01500.32C	MG10311	Nichelato	Zama	60x18	25

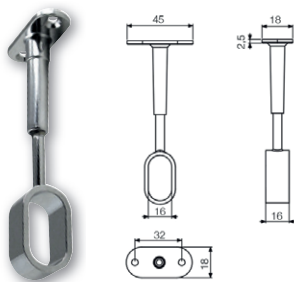

REGGITUBO REGOLABILE APERTO

CODICE	COD. BREVE	FINITURA	MAT.	INGOMBRO MM	BOX PZ.
42056Z03000.32	MG30211	Cromato	Zama	Per tubo da Ø30x15	1

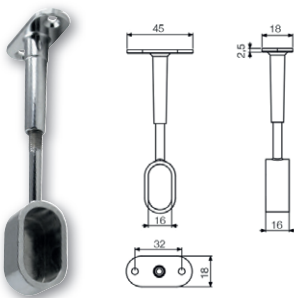

REGGITUBO REGOLABILE CHIUSO

CODICE	COD. BREVE	FINITURA	MAT.	INGOMBRO MM	BOX PZ.
42057Z03000.32	MG30212	Cromato	Zama	Per tubo da Ø30x15	1

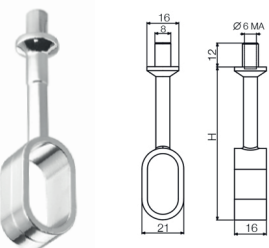

REGGITUBO APERTO FISSAGGIO PASSANTE

CODICE	COD. BREVE	FINITURA	MAT.	INGOMBRO MM	BOX PZ.
42129Z0300A.32	MG42899	Cromato	Zama	Per tubo da 30x15	1

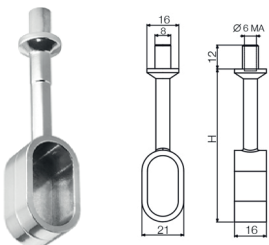

REGGITUBO CHIUSO FISSAGGIO PASSANTE

CODICE	COD. BREVE	FINITURA	MAT.	INGOMBRO MM	BOX PZ.
42129Z0300C.32	MG42900	Cromato	Zama	Per tubo da 30x15	1

**NEW**

REGGITUBO REGOLABILE APERTO

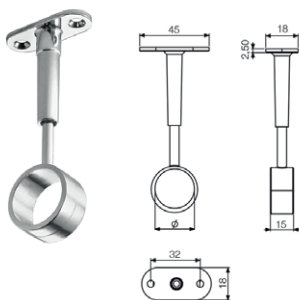

CODICE	COD. BREVE	FINITURA	MAT.	INGOMBRO MM	BOX PZ.
42119Z01800.32	MG43378	Cromato	Zama	Per tubo diam.mm.18	1
42119Z02500.32	MG43426	Cromato	Zama	Per tubo diam.mm.25	1

**NEW**

REGGITUBO REGOLABILE CHIUSO

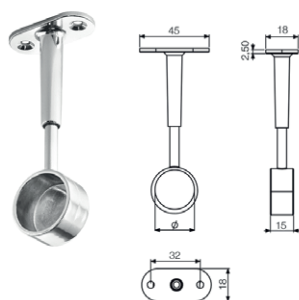

CODICE	COD. BREVE	FINITURA	MAT.	INGOMBRO MM	BOX PZ.
42016Z01800.32	MG43379	Cromato	Zama	Per tubo diam.mm.18	1
42016Z02500.32	MG43427	Cromato	Zama	Per tubo diam.mm.25	1



REGGITUBO TONDO PER PALO

CODICE	COD. BREVE	FINITURA	MAT.	INGOMBRO MM	BOX PZ.
42130Z01800.32	MG42901	Cromato	Zama	Per tubo da 18 mm	1
42130Z02500.32	MG42902	Cromato	Zama	Per tubo da 25 mm	1



REGGITUBO TONDO CON GHIERA SVITABILE PER PALO

CODICE	COD. BREVE	FINITURA	MAT.	INGOMBRO MM	BOX PZ.
42130Z01801.32	MG42903	Cromato	Zama	Per tubo da 18 mm	1
42130Z02501.32	MG42904	Cromato	Zama	Per tubo da 25 mm	1



REGGITUBO IN PLASTICA PER TUBO

CODICE	COD. BREVE	FINITURA	MAT.	INGOMBRO MM	BOX PZ.
RT30PGA	RT30PGA	Alluminio	Plastica	Per tubo da 30x15	100



REGGITUBO IN PLASTICA PER TUBO

CODICE	COD. BREVE	FINITURA	MAT.	INGOMBRO MM	BOX PZ.
42131.00000.F1	MG42853	Bianco	Plastica	Per tubo da 30x15	100
42131.00000.G1	MG42854	Marrone	Plastica	Per tubo da 30x15	100



REGGITUBO IN PLASTICA PER TUBO

CODICE	COD. BREVE	FINITURA	MAT.	INGOMBRO MM	BOX PZ.
42132.05000.F1	MG42874	Bianco	Plastica	Per tubo da Ø 18	100
42132.05000.G1	MG42875	Marrone	Plastica	Per tubo da Ø 18	100



SPAZZOLINO PARAPOLVERE IN FRESATA

CODICE	COD. BREVE	FINITURA	MAT.	INGOMBRO MM	BOX PZ.
52028.C2150.F1	MG43891	Bianco	Plastico	Pelo H15 L 2150	100
52028.C2150.G1	MG43892	Marrone	Plastico	Pelo H15 L 2150	100
52028.C2150.P1	MG43893	Nero	Plastico	Pelo H15 L 2150	100
52028.C2150.P2	MG43932	Grigio	Plastico	Pelo H15 L 2150	100
52028.C2151.F1	MG43887	Bianco	Plastico	Pelo H11 L 2150	100
52028.C2151.G1	MG43888	Marrone	Plastico	Pelo H11 L 2150	100
52028.C2151.P1	MG43889	Nero	Plastico	Pelo H11 L 2150	100
52028.C2151.P2	MG43890	Grigio	Plastico	Pelo H11 L 2150	100



SPAZZOLINO PARAPOLVERE IN FRESATA

CODICE	COD. BREVE	FINITURA	MAT.	INGOMBRO MM	BOX PZ.
52028.C2600.F1	MG30634	Bianco	Plastico	Pelo H15 L 2600	100
52028.C2600.P1	MG30633	Nero	Plastico	Pelo H15 L 2600	100
52028.C2601.F1	MG43894	Bianco	Plastico	Pelo H11 L 2600	100
52028.C2601.P1	MG36048	Nero	Plastico	Pelo H11 L 2600	100



SPAZZOLINO PARAPOLVERE ADESIVO

CODICE	COD. BREVE	FINITURA	MAT.	INGOMBRO MM	BOX PZ.
52077.00900.F1	MG43884	Bianco	Plastico	Pelo H9	200 mt
52077.00900.G1	MG43931	Marrone	Plastico	Pelo H9	200 mt
52077.00900.P1	MG43882	Nero	Plastico	Pelo H9	200 mt
52077.00900.P2	MG43883	Grigio	Plastico	Pelo H9	200 mt



SPAZZOLINO PARAPOLVERE ADESIVO

CODICE	COD. BREVE	FINITURA	MAT.	INGOMBRO MM	BOX PZ.
52077.01300.P1	MG43885	Nero	Plastico	Pelo H13	300 mt
52077.01300.P2	MG43886	Grigio	Plastico	Pelo H13	300 mt

**NEW** BATTUTA GRAFFABILE

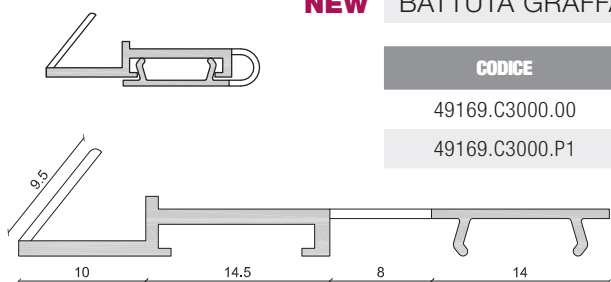

CODICE	COD. BREVE	FINITURA	MAT.	BOX PZ.
49169.C3000.00	MG42876	Opalino	Plastica	1
49169.C3000.P1	MG44527	Nero	Plastica	1



GUIDA STICK

CODICE	COD. BREVE	FINITURA	MAT.	INGOMBRO MM	BOX PZ.
41003.30001.G1	MG42726	Marrone	Plastica	h mm 16 - L mm 300	20
41003.50001.G1	MG42725	Marrone	Plastica	h mm 16 - L mm 500	20
41003.30000.G1	MG10161	Marrone	Plastica	h mm 20 - L mm 300	20
41003.50000.G1	MG10163	Marrone	Plastica	h mm 20 - L mm 500	20



ANGOLO PER LETTO

CODICE	COD. BREVE	FINITURA	MAT.	BOX PZ.
41056.19000.P1	MG43603	Nero	ferro	4

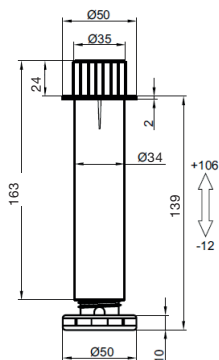
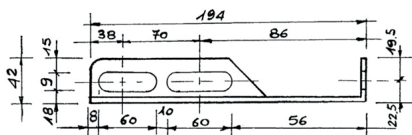

PIEDINO REGOLABILE DA LETTO

CODICE	COD. BREVE	FINITURA	MAT.	INGOMBRO MM	BOX PZ.
53161.16000.P1	MG43699	Nero	Plastica	160 mm	20





**NEW** RETE PROFILO 40X30MM



Angolo taglio laser

CODICE	COD. BREVE	FINITURA	MAT.	INGOMBRO MM	BOX PZ.
RE.L80190	MG45092	Nero	Ferro + Legno	800X1900	1
RE.L80195	MG45093	Nero	Ferro + Legno	800X1950	1
RE.L80200	MG45094	Nero	Ferro + Legno	800X2000	1
RE.L90190	MG45095	Nero	Ferro + Legno	900X1900	1
RE.L90195	MG45096	Nero	Ferro + Legno	900X1950	1
RE.L90200	MG45097	Nero	Ferro + Legno	900X2000	1
RE.L120190	MG45098	Nero	Ferro + Legno	1200X1900	1
RE.L120195	MG45099	Nero	Ferro + Legno	1200X1950	1
RE.L120200	MG45100	Nero	Ferro + Legno	1200X2000	1
RE.P160190	MG45101	Nero	Ferro + Legno	1600X1900	1
RE.P160195	MG45102	Nero	Ferro + Legno	1600X1950	1
RE.P160200	MG45103	Nero	Ferro + Legno	1600X2000	1
RE.P180190	MG45104	Nero	Ferro + Legno	1800X1900	1
RE.P180195	MG45105	Nero	Ferro + Legno	1800X1950	1
RE.P180200	MG45106	Nero	Ferro + Legno	1800X2000	1

**NEW** MECCANISMO A 2 POSIZIONI



CODICE	COD. BREVE	FINIT.	MAT.	DESCRIZIONE	INGOMBRO MM	BOX PZ.
MEC.T80/90	MG45107	Nero	Ferro	Meccanismo 2 posizioni con pistoni 600+400 N	per reti larghezza 800mm e 900mm	1
BARRA.T80	MG45108	Nero	Ferro	Barra di torsione	per reti larghezza 800mm	1
BARRA.T90	MG45109	Nero	Ferro	Barra di torsione	per reti larghezza 900mm	1
MEC.T120	MG45110	Nero	Ferro	Meccanismo 2 posizioni con pistoni 800+600 N	per reti larghezza 1200mm	1
BARRA.T120	MG45111	Nero	Ferro	Barra di torsione	per reti larghezza 1200mm	1
MEC.T140-180	MG45112	Nero	Ferro	Meccanismo 2 posizioni con pistoni 1250+1000 N	per reti larghezza 1600mm e 1800mm	1
BARRA.T160	MG45113	Nero	Ferro	Barra di torsione	per reti larghezza 1600mm	1
BARRA.T180	MG45114	Nero	Ferro	Barra di torsione	per reti larghezza 1800mm	1

**NEW** MECCANISMO A 1 POSIZIONE



CODICE	COD. BREVE	FINIT.	MAT.	DESCRIZIONE	INGOMBRO MM	BOX PZ.
MEC.A80-90	MG45115	Nero	Ferro	Meccanismo 1 posizione con pistone 600 N	per reti larghezza 800mm e 900mm	1
MEC.A120	MG45116	Nero	Ferro	Meccanismo 1 posizione con pistone 800 N	per reti larghezza 1200mm	1
MEC.A140-160	MG45117	Nero	Ferro	Meccanismo 1 posizione con pistone 1000 N	per reti larghezza 1600mm	1
MEC.A180	MG45118	Nero	Ferro	Meccanismo 1 posizione con pistone 1150 N	per reti larghezza 1800mm	1

**NEW** SET 4 PIEDI CON TAPPO FILETTATO M10

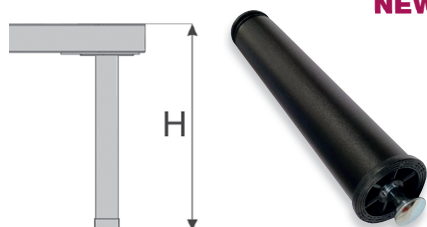

CODICE	COD. BREVE	FINITURA	MAT.	INGOMBRO MM	BOX PZ.
PI.D50H30	MG45119	Nero	Ferro	diam.50 h.300mm	1
PI.D50H35	MG45120	Nero	Ferro	diam.50 h.350mm	1
PI.D50H40	MG45121	Nero	Ferro	diam.50 h.400mm	1

## FERRO DA LETTO AD INCASTRO



CODICE	COD. BREVE	FINITURA	MAT.	INGOMBRO MM	BOX PZ.
41009.09500.33	MG43229	Zincato	Ferro	95 mm	25 set
41009.12000.33	MG43230	Zincato	Ferro	120 mm	25 set
41009.15000.33	MG43231	Zincato	Ferro	150 mm	25 set

## FERRO DA LETTO A 1 GANCIO



CODICE	COD. BREVE	FINITURA	MAT.	INGOMBRO MM	BOX PZ.
41010.08000.21	MG43105	Grezzo	Ferro	80 mm	48 set

## FERRO DA LETTO A 2 GANCI



CODICE	COD. BREVE	FINITURA	MAT.	INGOMBRO MM	BOX PZ.
41010.10000.21	MG43106	Grezzo	Ferro	100 mm	48 set
41010.12000.21	MG10175	Grezzo	Ferro	120 mm	48 set
41010.14000.21	MG10176	Grezzo	Ferro	140 mm	48 set
41010.16000.21	MG43107	Grezzo	Ferro	160 mm	48 set

## FERRO DA LETTO CON PUNTA



CODICE	COD. BREVE	FINITURA	MAT.	INGOMBRO MM	BOX PZ.
41011.12000.64	MG10177	Tropicalizzato	Ferro	130 mm	25 set

## FERRI DA LETTO



CODICE	COD. BREVE	FINITURA	MAT.	INGOMBRO MM	BOX PZ.
41046.00000.64	MG43108	Tropicalizzato	Ferro		25 set

## FERRO LETTO A BAIONETTA



CODICE	COD. BREVE	FINITURA	MAT.	INGOMBRO MM	BOX PZ.
41047.15000.33	MG43109	Zincato	Ferro	150x25	50 set

## FERRO DA LETTO REGOLABILE



CODICE	COD. BREVE	FINITURA	MAT.	INGOMBRO MM	BOX PZ.
41048.14000.64	MG43110	Tropicalizzato	Ferro	140 mm	24 set



# PERMO



Vite femmina Ø5

Materiale: Ferro

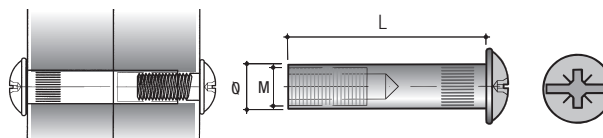

CODICE	FINITURA	MISURE mm			BOX
		Ø	M	L	
VF01FNL	Nichelato	5	4	27	100
<b>VF01FNL.2000</b>	<b>Nichelato</b>	<b>5</b>	<b>4</b>	<b>27</b>	<b>2.000</b> <b>BEST PRICE!</b>
VF01FBR	Bronzato	5	4	27	100
VF04FNL	Nichelato	5	4	30	100
<b>VF04FNL.2000</b>	<b>Nichelato</b>	<b>5</b>	<b>4</b>	<b>30</b>	<b>2.000</b> <b>BEST PRICE!</b>
VF04FBR	Bronzato	5	4	30	100



Vite TBL M4

Materiale: Ferro

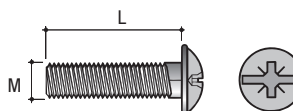

CODICE	FINITURA	MISURE mm		BOX
		M	L	
VC01FNL	Nichelato	4	15	100
<b>VC01FNL.5000</b>	<b>Nichelato</b>	<b>4</b>	<b>15</b>	<b>5.000</b> <b>BEST PRICE!</b>
VC01FBR	Bronzato	4	15	100
VC02FNL	Nichelato	4	20	100
<b>VC02FNL.5000</b>	<b>Nichelato</b>	<b>4</b>	<b>20</b>	<b>5.000</b> <b>BEST PRICE!</b>
VC02FBR	Bronzato	4	20	100
VC03FNL	Nichelato	4	25	100
<b>VC03FNL.4000</b>	<b>Nichelato</b>	<b>4</b>	<b>25</b>	<b>4.000</b> <b>BEST PRICE!</b>
VC03FBR	Bronzato	4	25	100
VC04FNL	Nichelato	4	30	100
VC04FBR	Bronzato	4	30	100



Vite femmina Ø8

Materiale: Ferro

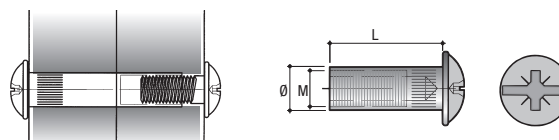

CODICE	FINITURA	MISURE mm			BOX
		Ø	M	L	
VF03FNL	Nichelato	8	6	30	100
<b>VF03FNL.1500</b>	<b>Nichelato</b>	<b>8</b>	<b>6</b>	<b>30</b>	<b>1.500</b> <b>BEST PRICE!</b>
VF03FBR	Bronzato	8	6	30	100



Vite TBL M6

Materiale: Ferro

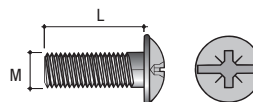

CODICE	FINITURA	MISURE mm		BOX
		M	L	
VC05FNL	Nichelato	6	14	100
<b>VC05FNL.3000</b>	<b>Nichelato</b>	<b>6</b>	<b>14</b>	<b>3.000</b> <b>BEST PRICE!</b>
VC05FBR	Bronzato	6	14	100
VC11FNL	Nichelato	6	20	100
<b>VC11FNL.2500</b>	<b>Nichelato</b>	<b>6</b>	<b>20</b>	<b>2.500</b> <b>BEST PRICE!</b>
VC11FBR	Bronzato	6	20	100
VC06FNL	Nichelato	6	25	100
<b>VC06FNL.2500</b>	<b>Nichelato</b>	<b>6</b>	<b>25</b>	<b>2.500</b> <b>BEST PRICE!</b>
VC06FBR	Bronzato	6	25	100
VC07FNL	Nichelato	6	30	100
<b>VC07FNL.2000</b>	<b>Nichelato</b>	<b>6</b>	<b>30</b>	<b>2.000</b> <b>BEST PRICE!</b>
VC07FBR	Bronzato	6	30	100
VC08FNL	Nichelato	6	35	100
VC08FBR	Bronzato	6	35	100



Giunto KEKU ad incastro

Materiale: Plastica

CODICE	FINITURA	BOX
41045.00000.P1	Nero	100

Giunto KEKU verticale

Materiale: Plastica

CODICE	FINITURA	BOX
41044.00000.P1	Nero	100

Giunzione a baionetta

Materiale: Plastica

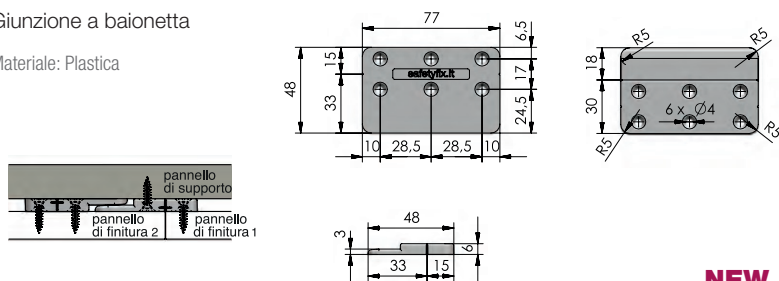

**NEW**

CODICE	CODICE BREVE	FINITURA	MISURE mm	BOX
41065.07600.P1	MG45324	Nero	77x48	50

Mensolina c/anello

Materiale: Ferro

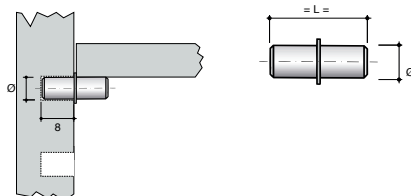

CODICE	FINITURA	MISURE mm		BOX
		Ø	= L =	
ME08FZ	Zincato	5	16	100
<b>ME08FZ.5000</b>	<b>Zincato</b>	<b>5</b>	<b>16</b>	<b>5.000</b>

**BEST PRICE!**

Reggipiano

Materiale: Ferro

CODICE	FINITURA	MISURE M mm	BOX
42022.01500.04	Bronzato	M5 - 7 x 16	100
42022.01500.17	Ottonato	M5 - 7 x 16	100
42022.01500.32	Nichelato	M5 - 7 x 16	100
42022.02000.04	Bronzato	M5 - 7 x 20	100
42022.02000.17	Ottonato	M5 - 7 x 20	100
42022.02000.32	Nichelato	M5 - 7 x 20	100
42022.02400.04	Bronzato	M5 - 7 x 25	100
42022.02400.17	Ottonato	M5 - 7 x 25	100
42022.02400.32	Nichelato	M5 - 7 x 25	100
42022.03000.04	Bronzato	M5 - 7 x 30	100
42022.03000.17	Ottonato	M5 - 7 x 30	100
42022.03000.32	Nichelato	M5 - 7 x 30	100

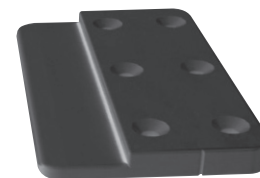



Reggipiano con anello

Materiale: Ferro

CODICE	FINITURA	MISURE M mm	BOX
42023.01000.04	Bronzato	M5 - 7 x 16	100
42023.01000.17	Ottonato	M5 - 7 x 16	100
42023.01000.32	Nichelato	M5 - 7 x 16	100
42023.02000.04	Bronzato	M5 - 7 x 20	100
42023.02000.17	Ottonato	M5 - 7 x 20	100
42023.02000.32	Nichelato	M5 - 7 x 20	100
42023.02500.04	Bronzato	M5 - 7 x 25	100
42023.02500.17	Ottonato	M5 - 7 x 25	100
42023.02500.32	Nichelato	M5 - 7 x 25	100
42023.03000.04	Bronzato	M5 - 7 x 30	100
42023.03000.17	Ottonato	M5 - 7 x 30	100
42023.03000.32	Nichelato	M5 - 7 x 30	100

Reggipiano con foro e perno nichelato (da usare con vite VE01)

Materiale: Zama

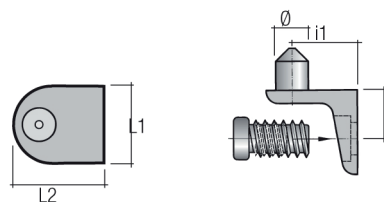

CODICE	FINITURA	MISURE mm					BOX
		Ø	i	L1	L2	i1	
ME03ZNL	Nichelato	5	8	12	14	10	100

Reggipiano due perni nichelato

Materiale: Zama

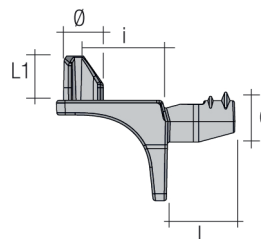

CODICE	FINITURA	MISURE mm					BOX
		Ø	L	L1	i	i1	
ME64ZNL	Nichelato	5	7,5	5,2	10	2,5	100

Reggipiano un perno nichelato

Materiale: Zama

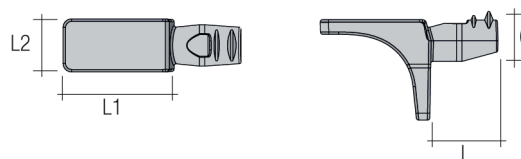

CODICE	FINITURA	MISURE mm				BOX
		Ø	L	L1	L2	
ME65ZNL	Nichelato	5	7,5	13	6,5	100



Reggicristallo con perno

Materiale: Zama

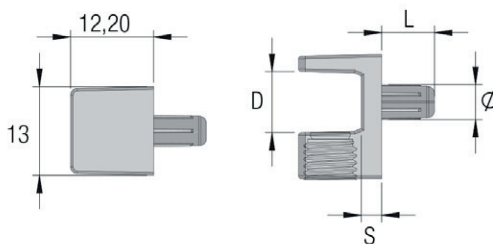

CODICE	FINITURA	MISURE mm				BOX
		Ø	L	D	S	
MV34ZNL	Nichelato	5	8	8	3	100
MV34ZNN	Nichelato nero	5	8	8	3	100



Reggicristallo per vite

Materiale: Zama

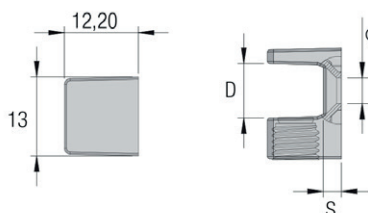

CODICE	FINITURA	MISURE mm			BOX
		Ø	D	S	
MV33ZNL	Nichelato	3,5	8	3	100
MV33ZNN	Nichelato nero	3,5	8	3	100



Reggicristallo con gommino e perno

Materiale: Zama + Plastica

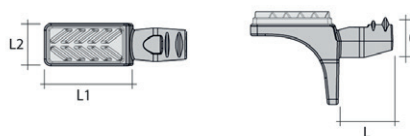

CODICE	FINITURA	MISURE mm				BOX
		Ø	L	L1	L2	
MV64ZNL	Nichelato	5	7,5	13	6,5	100



Mensolina con vite di bloccaggio

Materiale: Zama

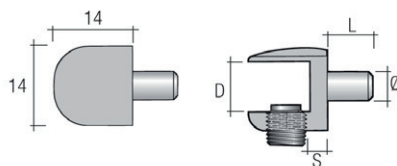

CODICE	FINITURA	MISURE mm				BOX
		Ø	L	D	S	
MV08ZNL	Nichelato	5	8	9	2,5	100
MV08ZO	Ottonato	5	8	9	2,5	100
MV08ZBR	Bronzato	5	8	9	2,5	100



Mensolina con vite di bloccaggio e foro

Materiale: Zama

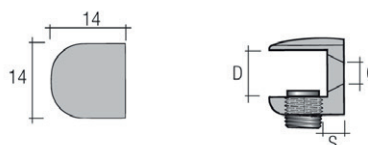

CODICE	FINITURA	MISURE mm			BOX
		Ø	D	S	
MV09ZNL	Nichelato	4	9	2,5	100
MV09ZO	Ottonato	4	9	2,5	100
MV09ZBR	Bronzato	4	9	2,5	100





Reggripiano in ottone con gomma

Materiale: Gomma e Ottone

CODICE	FINITURA	MISURE mm Ø	BOX
42062.01200.F1	Bianco	12	100
42062.01200.G1	Marrone	12	100
42062.01200.P1	Nero	12	100

Articoli correlati



Inserto Shelf Block

Materiale: Plastica

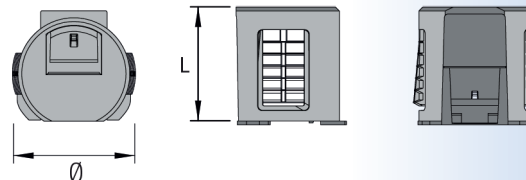

CODICE	FINITURA	MISURE mm			BOX
		Ø	L		
S0051PGR	Grigia	15	15	18	100

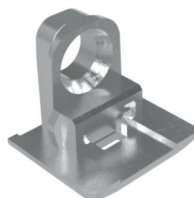

Staffa

Materiale: Zama

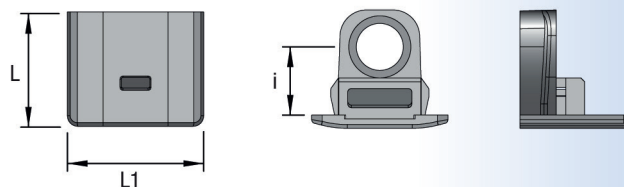

CODICE	FINITURA	MISURE mm				BOX
		L	L1	i		
S0061ZNL	Nichelata	15	18	9	18	100

Articoli correlati



Eurovite testa cilindrica

Materiale: Ferro

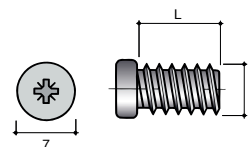

CODICE	FINITURA	MISURE mm		BOX
		Ø	L	
VE03FZ	Zincata	6	9	100
<b>VE03FZ.2000</b>	<b>Zincata</b>	<b>6</b>	<b>9</b>	<b>2.000</b>
VE01FZ	Zincata	6	11	100
<b>VE01FZ.2000</b>	<b>Zincata</b>	<b>6</b>	<b>11</b>	<b>2.000</b>
VE02FZ	Zincata	6	13	100
<b>VE02FZ.2000</b>	<b>Zincata</b>	<b>6</b>	<b>13</b>	<b>2.000</b>



**PERMO**

Supporto Ø 19

Materiale: Plastica

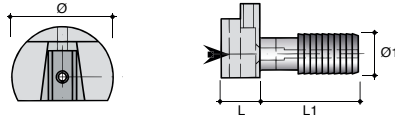

CODICE	FINITURA	MISURE mm				BOX
		Ø	L	L1	Ø1	
SI02PB	Bianco	19	7	25	9	100
SI02PNE	Nero	19	7	25	9	100
SI02PMA	Marrone	19	7	25	9	100

Staffa standard

Materiale: Zama

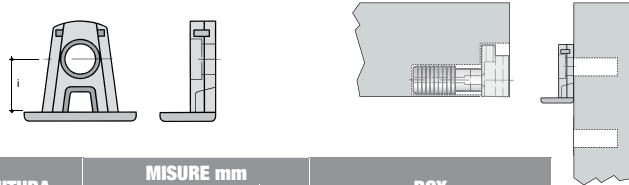

CODICE	FINITURA	MISURE mm		BOX
		i		
ST13ZNL	Nichelata	9	18	100
<b>ST13ZNL.2000</b>	<b>Nichelata</b>	<b>9</b>	<b>18</b>	<b>2.000</b> <b>BEST PRICE!</b>
ST13ZBR	Bronzata	9	18	100

Supporto Ø 25

Materiale: Plastica

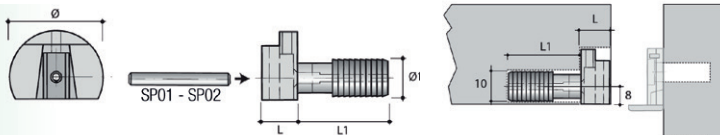

CODICE	FINITURA	MISURE mm				BOX
		Ø	L	L1	Ø1	
SI01PB	Bianco	25	10	25	9,6	100
SI01PNE	Nero	25	10	25	9,6	100
SI01PMA	Marrone	25	10	25	9,6	100

Staffa standard

Materiale: Zama

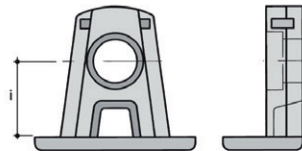

CODICE	FINITURA	MISURE mm		BOX
		i		
ST01ZNL	Nichelata	12,5	25	100
<b>ST01ZNL.2000</b>	<b>Nichelata</b>	<b>12,5</b>	<b>25</b>	<b>2.000</b> <b>BEST PRICE!</b>
ST01ZBR	Bronzata	12,5	25	100

Spina in ferro

Materiale: Ferro



CODICE	FINITURA	MISURE mm		BOX
		Ø	L	
SP01FZ	Zincato	3	25	100

Eurovite testa cilindrica

Materiale: Ferro

CODICE	FINITURA	MISURE mm		BOX
		Ø	L	
VE03FZ	Zincata	6	9	100
<b>VE03FZ.2000</b>	<b>Zincata</b>	<b>6</b>	<b>9</b>	<b>2.000</b> <b>BEST PRICE!</b>
VE01FZ	Zincata	6	11	100
<b>VE01FZ.2000</b>	<b>Zincata</b>	<b>6</b>	<b>11</b>	<b>2.000</b> <b>BEST PRICE!</b>
VE02FZ	Zincata	6	13	100
<b>VE02FZ.2000</b>	<b>Zincata</b>	<b>6</b>	<b>13</b>	<b>2.000</b> <b>BEST PRICE!</b>

Articoli correlati



Articoli correlati

Articoli correlati

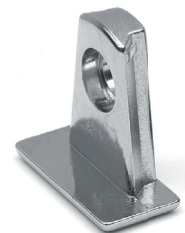

Articoli correlati

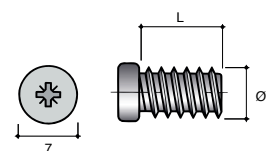

# PERMO

Articoli correlati



Articoli correlati

Eccentrico Ø15

Materiale: Zama

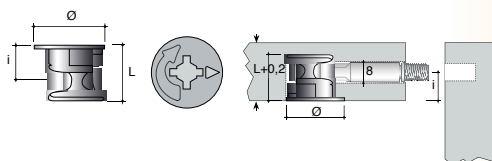

CODICE	FINITURA	MISURE mm				BOX
			Ø	L	i	
EC20ZZ	Zincato	15/16	15	12	7,75	100
<b>EC20ZZ.2000</b>	<b>Zincato</b>	<b>15/16</b>	<b>15</b>	<b>12</b>	<b>7,75</b>	<b>2.000</b> <b>BEST PRICE!</b>
EC30ZZ	Zincato	19	15	13,5	9,30	100
<b>EC30ZZ.2000</b>	<b>Zincato</b>	<b>19</b>	<b>15</b>	<b>13,5</b>	<b>9,30</b>	<b>2.000</b> <b>BEST PRICE!</b>

Coprieccentrico

Materiale: Plastica

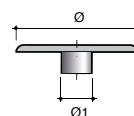

CODICE	FINITURA	BOX
CF04PB	Bianco	100
CF04PCI	Ciliegio	100
CF04PNE	Nero	100

Tirante per eccentrico Ø 15

Materiale: Ferro

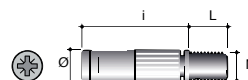

CODICE	FINITURA	MISURE mm				BOX
		Ø	L	M	i	
TE03FZ	Zincato	7	8	M6	34	100
TE04FZ	Zincato	7	8	M6	24	100

Tirante per eccentrico Ø 15

Materiale: Ferro

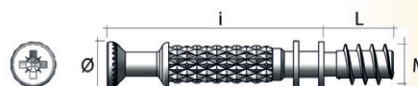

CODICE	FINITURA	MISURE mm				BOX
		Ø	L	M	i	
TM02FZ	Zincato	7	11	6euro	24	100
<b>TM02FZ.2500</b>	<b>Zincato</b>	<b>7</b>	<b>11</b>	<b>6euro</b>	<b>24</b>	<b>2.500</b> <b>BEST PRICE!</b>
TM01FZ	Zincato	7	11	6euro	34	100
<b>TM01FZ.2000</b>	<b>Zincato</b>	<b>7</b>	<b>11</b>	<b>6euro</b>	<b>34</b>	<b>2.000</b> <b>BEST PRICE!</b>

Tirante per eccentrico Ø 15

Materiale: Ferro

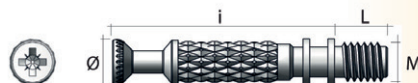

CODICE	FINITURA	MISURE mm				BOX
		Ø	L	M	i	
TM04FZ	Zincato	7	8,5	M6	24	100
<b>TM04FZ.2500</b>	<b>Zincato</b>	<b>7</b>	<b>8,5</b>	<b>M6</b>	<b>24</b>	<b>2.500</b> <b>BEST PRICE!</b>
TM03FZ	Zincato	7	8,5	M6	34	100
<b>TM03FZ.2000</b>	<b>Zincato</b>	<b>7</b>	<b>8,5</b>	<b>M6</b>	<b>34</b>	<b>2.000</b> <b>BEST PRICE!</b>

**PERMO**

Barilotto Trio con bordo  
Materiale: Zama  
B082ZZ

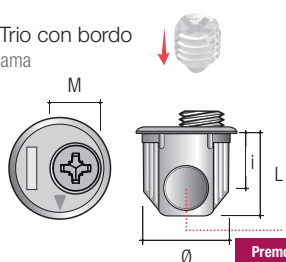

Premontato

Barilotto Trio senza bordo  
Materiale: Zama  
B083ZZ

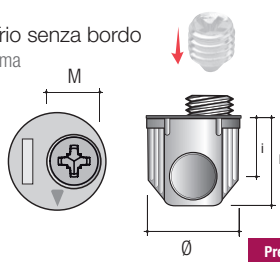

Premontato

Articoli correlati



CODICE	DESCRIZIONE	FINITURA	MISURE mm				BOX
			Ø	L	M	i	
B082ZZ	Con bordo	Zincato	14	14,3	M8	9	100
<b>B082ZZ.1000</b>	<b>Con bordo</b>	<b>Zincato</b>	<b>14</b>	<b>14,3</b>	<b>M8</b>	<b>9</b>	<b>1.000</b> <b>BEST PRICE!</b>
B083ZZ	Senza bordo	Zincato	14	14,3	M8	9	100
<b>B083ZZ.1000</b>	<b>Senza bordo</b>	<b>Zincato</b>	<b>14</b>	<b>14,3</b>	<b>M8</b>	<b>9</b>	<b>1.000</b> <b>BEST PRICE!</b>

Tirante Trio  
Materiale: Ferro

CODICE	FINITURA	MISURE mm				BOX
		Ø	M	i	F	
TF80FZ	Zincato	7	M6	20	21	100
<b>TF80FZ.2000</b>	<b>Zincato</b>	<b>7</b>	<b>M6</b>	<b>20</b>	<b>21</b>	<b>2.000</b> <b>BEST PRICE!</b>
TF81FZ	Zincato	7	M6	27	28	100
<b>TF81FZ.1500</b>	<b>Zincato</b>	<b>7</b>	<b>M6</b>	<b>27</b>	<b>28</b>	<b>1.500</b> <b>BEST PRICE!</b>
TF82FZ	Zincato	7	M6	33	34	100
<b>TF82FZ.1000</b>	<b>Zincato</b>	<b>7</b>	<b>M6</b>	<b>33</b>	<b>34</b>	<b>1.000</b> <b>BEST PRICE!</b>

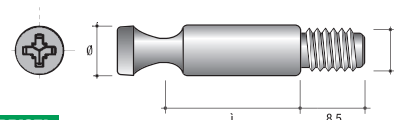

Bussola  
Materiale: ferro

CODICE	FINITURA	MISURE mm		BOX
		L	M	
65489.01300.00	zincata	13	M6	100
65489.01700.00	zincata	17	M6	100
65489.02000.00	zincata	20	M6	100
65489.02400.00	zincata	24	M6	100

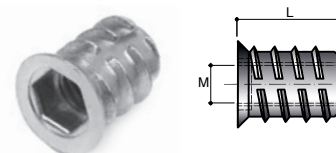

Bussola  
Materiale: Zama

CODICE	FINITURA	MISURE mm				BOX
		Ø	Ø1	L	M	
65489Z01000.00	Grezzo	8	9,5	10	M6	100
65489Z01300.00	Grezzo	8	9,5	13	M6	100
65489Z01500.00	Grezzo	8	9,5	15	M6	100
65489Z01700.00	Grezzo	8	9,5	17	M6	100
65489Z02000.00	Grezzo	8	9,5	20	M6	100

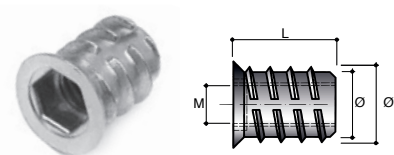

Copriforo

CF80

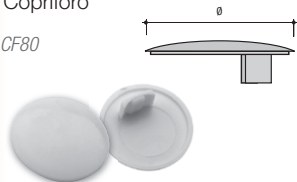

CF06

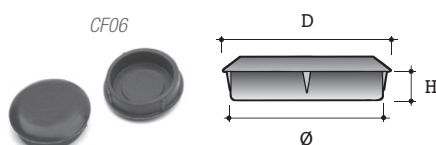

Materiale: Plastica

CODICE	FINITURA	MISURE mm			BOX
		Ø	H3	D	
CF80PB	Bianco	17			100
CF80PMA	Marrone	17			100
CF80PNE	Nero	17			100
CF80PAC	Acero	17			100
CF06PMA	Marrone	Ø14	H3	D 16	100
CF06PB	Bianco	Ø14	H3	D 16	100

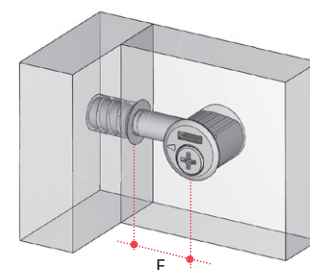

Articoli correlati

**PERMO**



Articoli correlati



Barilotto Ø14 senza bordo con grano M8

Materiale: Zama

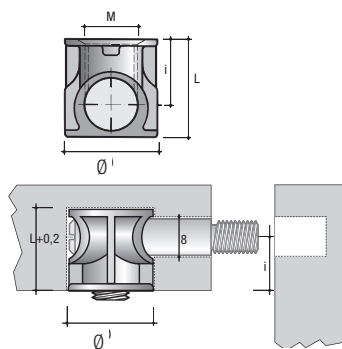

CODICE	FINITURA	MISURE mm					BOX	
			Ø	L	M	i		
B009ZZ + GR09ZZ	Zincata	16	14	13	8	8	100	
<b>B009ZZ.2000 + GR09ZZ.2000</b>	<b>Zincata</b>	<b>16</b>	<b>14</b>	<b>13</b>	<b>8</b>	<b>8</b>	<b>2.000</b>	<b>BEST PRICE!</b>
B009ZBR + GR09ZBR	Bronzata	16	14	13	8	8	100	
<b>B009ZBR.2000 + GR09ZBR.2000</b>	<b>Bronzata</b>	<b>16</b>	<b>14</b>	<b>13</b>	<b>8</b>	<b>8</b>	<b>2.000</b>	<b>BEST PRICE!</b>
B010ZZ + GR01ZZ	Zincata	18	14	14	8	9	100	
<b>B010ZZ.2000 + GR01ZZ.2000</b>	<b>Zincata</b>	<b>18</b>	<b>14</b>	<b>14</b>	<b>8</b>	<b>9</b>	<b>2.000</b>	<b>BEST PRICE!</b>
B010ZBR + GR01ZBR	Bronzata	18	14	14	8	9	100	
<b>B010ZBR.2000 + GR01ZBR.2000</b>	<b>Bronzata</b>	<b>18</b>	<b>14</b>	<b>14</b>	<b>8</b>	<b>9</b>	<b>2.000</b>	<b>BEST PRICE!</b>
B011ZZ + GR01ZZ	Zincata	20	14	15	8	10	100	
<b>B011ZZ.2000 + GR01ZZ.2000</b>	<b>Zincata</b>	<b>20</b>	<b>14</b>	<b>15</b>	<b>8</b>	<b>10</b>	<b>2.000</b>	<b>BEST PRICE!</b>
B011ZBR + GR01ZBR	Bronzata	20	14	15	8	10	100	
<b>B011ZBR.2000 + GR01ZBR.2000</b>	<b>Bronzata</b>	<b>20</b>	<b>14</b>	<b>15</b>	<b>8</b>	<b>10</b>	<b>2.000</b>	<b>BEST PRICE!</b>
B031ZZ + GR08ZZ	Zincata	25	14	17,5	8	12,5	100	
<b>B031ZZ.2000 + GR08ZZ.2000</b>	<b>Zincata</b>	<b>25</b>	<b>14</b>	<b>17,5</b>	<b>8</b>	<b>12,5</b>	<b>2.000</b>	<b>BEST PRICE!</b>
B031ZBR + GR08ZBR	Bronzata	25	14	17,5	8	12,5	100	
<b>B031ZBR.2000 + GR08ZBR.2000</b>	<b>Bronzata</b>	<b>25</b>	<b>14</b>	<b>17,5</b>	<b>8</b>	<b>12,5</b>	<b>2.000</b>	<b>BEST PRICE!</b>



Barilotto Ø14 con bordo con grano M8

Materiale: Zama

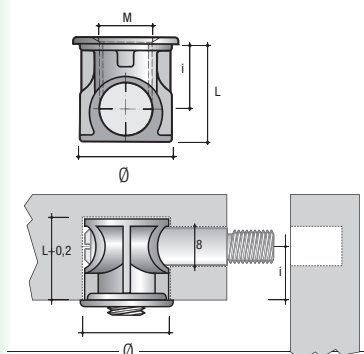

CODICE	FINITURA	MISURE mm					BOX	
			Ø	L	M	i		
B007ZZ + GR09ZZ	Zincata	16	14	13	8	8	100	
<b>B007ZZ.2000 + GR09ZZ.2000</b>	<b>Zincata</b>	<b>16</b>	<b>14</b>	<b>13</b>	<b>8</b>	<b>8</b>	<b>2.000</b>	<b>BEST PRICE!</b>
B007ZBR + GR09ZBR	Bronzata	16	14	13	8	8	100	
<b>B007ZBR.2000 + GR09ZBR.2000</b>	<b>Bronzata</b>	<b>16</b>	<b>14</b>	<b>13</b>	<b>8</b>	<b>8</b>	<b>2.000</b>	<b>BEST PRICE!</b>
B001ZZ + GR01ZZ	Zincata	18	14	14	8	9	100	
<b>B001ZZ.2000 + GR01ZZ.2000</b>	<b>Zincata</b>	<b>18</b>	<b>14</b>	<b>14</b>	<b>8</b>	<b>9</b>	<b>2.000</b>	<b>BEST PRICE!</b>
B001ZBR + GR01ZBR	Bronzata	18	14	14	8	9	100	
<b>B001ZBR.2000 + GR01ZBR.2000</b>	<b>Bronzata</b>	<b>18</b>	<b>14</b>	<b>14</b>	<b>8</b>	<b>9</b>	<b>2.000</b>	<b>BEST PRICE!</b>
B008ZZ + GR01ZZ	Zincata	20	14	15	8	10	100	
<b>B008ZZ.2000 + GR01ZZ.2000</b>	<b>Zincata</b>	<b>20</b>	<b>14</b>	<b>15</b>	<b>8</b>	<b>10</b>	<b>2.000</b>	<b>BEST PRICE!</b>
B008ZBR + GR01ZBR	Bronzata	20	14	15	8	10	100	
<b>B008ZBR.2000 + GR01ZBR.2000</b>	<b>Bronzata</b>	<b>20</b>	<b>14</b>	<b>15</b>	<b>8</b>	<b>10</b>	<b>2.000</b>	<b>BEST PRICE!</b>
B030ZZ + GR08ZZ	Zincata	25	14	17,5	8	12,5	100	
B030ZBR + GR08ZBR	Bronzata	25	14	17,5	8	12,5	100	

Tirante Ø7

Materiale: Ferro

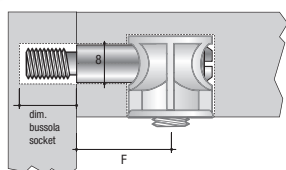
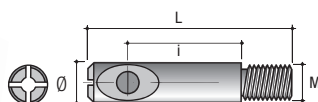

CODICE	FINITURA	MISURE mm					BOX	
		Ø	L	M	i	F		
TF02FZ	Zincato	7	35	6	20	21,5	100	
<b>TF02FZ.2000</b>	<b>Zincato</b>	<b>7</b>	<b>35</b>	<b>6</b>	<b>20</b>	<b>21,5</b>	<b>2.000</b>	<b>BEST PRICE!</b>
TF04FZ	Zincato	7	45	6	30	31,5	100	
<b>TF04FZ.1000</b>	<b>Zincato</b>	<b>7</b>	<b>45</b>	<b>6</b>	<b>30</b>	<b>31,5</b>	<b>1.000</b>	<b>BEST PRICE!</b>



Articoli correlati



Bariotto Ø16 senza bordo con grano

Materiale: Zama



CODICE	FINITURA	MISURE mm	MISURE mm				BOX
			Ø	L	M	i	
B013ZZ + GR05ZZ	Zincato	25	16	19,5	10	12,5	100
B013ZBR + GR05ZBR	Bronzato	25	16	19,5	10	12,5	100

Bariotto Ø16 con bordo con grano

Materiale: Zama



CODICE	FINITURA	MISURE mm	MISURE mm				BOX
			Ø	L	M	i	
B003ZZ + GR05ZZ	Zincato	25	16	19,5	10	12,5	100
B003ZBR + GR05ZBR	Bronzato	25	16	19,5	10	12,5	100

Tirante Ø10

Materiale: Ferro



CODICE	FINITURA	MISURE mm					BOX
		Ø	L	M	i	F	
TF06FZ	Zincato	10	36	8	20	21,5	100
TF08FZ	Zincato	10	46	8	30	31,5	100

Articoli correlati

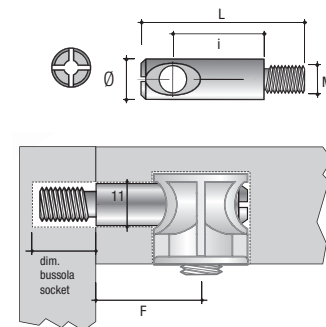
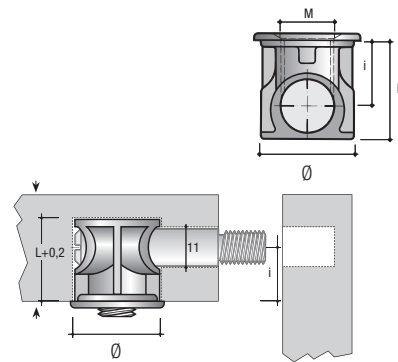
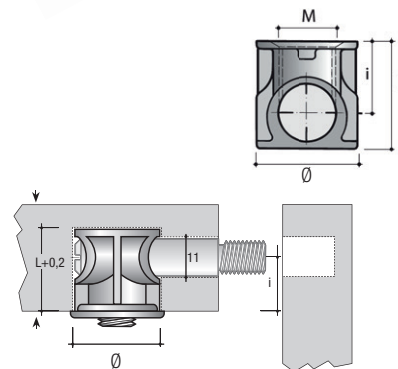

Articoli correlati

Articoli correlati



Articoli correlati

Eccentrico "STRONG" Ø 35

Materiale: Zama

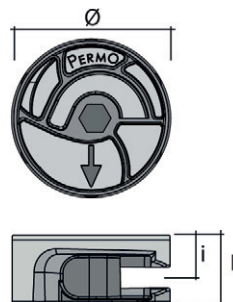

CODICE	FINITURA	MISURE mm			BOX
		Ø	L	i	
EC40ZL	Grezzo	35	15	9,5	100

Tirante per Eccentrico "STRONG"

Materiale: Ferro

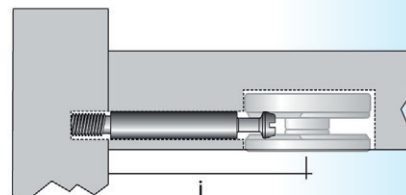

CODICE	FINITURA	MISURE mm				BOX
		Ø	L	M	i	
TE137FZ	Zincata	8,5	9,5	M8	35	100
TE135FZ	Zincata	8,5	9,5	M8	55	100

Copricentrico

Materiale: Plastica

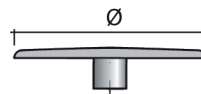

CODICE	FINITURA	MISURE mm	BOX
		Ø	
CF136PB	Bianco	35	100
CF136PNE	Nero	35	100
CF136PMA	Marrone	35	100

Giunzione e perno giunzione

Materiale: Zama e ferro

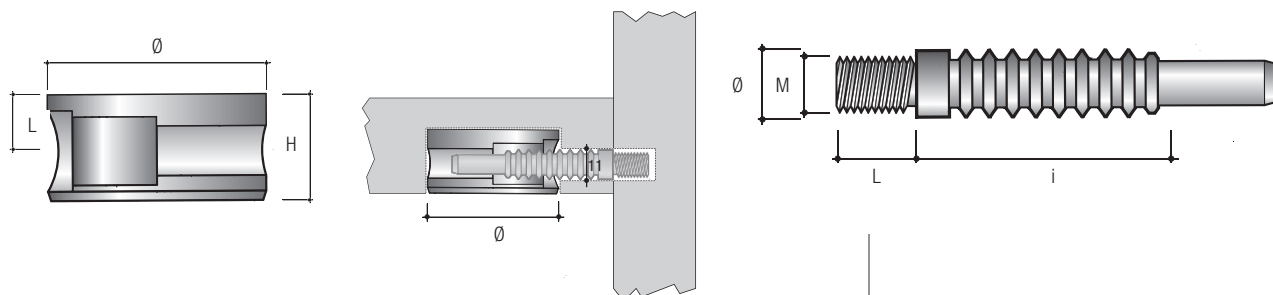

CODICE	COD. BREVE	FINITURA	DESCRIZIONE	MISURE mm					BOX
				Ø	H	L	M	i	
41007Z06400.21	MG10170	Zincato	Giunzione	35	17	9			100
			Perno	10		12	M8	35	
41007Z08400.21	MG10171	Zincato	Giunzione	35	17	9			100
			Perno	10		12	M8	55	
CF135PB		Bianco	Copriforo	39					100
CF136PB		Bianco	Copriforo	37					100

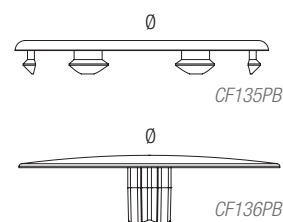

Bussola plastica

Materiale: Plastica

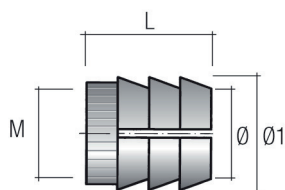

CODICE	MISURE mm				BOX
	Ø	Ø1	L	M	
BU61PN	8	9	11.5	M6	100
<b>BU61PN.5000</b>	<b>8</b>	<b>9</b>	<b>11.5</b>	<b>M6</b>	<b>5.000</b> <b>BEST PRICE!</b>
BU09PN	10	11	11	M6	100
<b>BU09PN.5000</b>	<b>10</b>	<b>11</b>	<b>11</b>	<b>M6</b>	<b>5.000</b> <b>BEST PRICE!</b>
BU10PN	10	11	13	M6	100
<b>BU10PN.5000</b>	<b>10</b>	<b>11</b>	<b>13</b>	<b>M6</b>	<b>5.000</b> <b>BEST PRICE!</b>



Bussola nylon

Materiale: Plastica

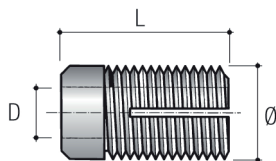

CODICE	MISURE mm			BOX
	Ø	L	D	
BU17PN	5	9.5	3	100

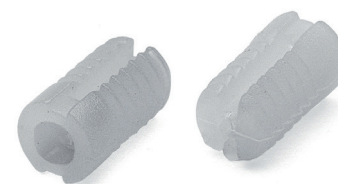

# PERMO



Bussola

Materiale: ferro

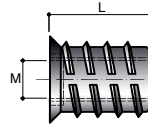

CODICE	FINITURA	MISURE mm		BOX
		L	M	
65493.01000.00	zincata	10	M4	100
65489.01300.00	zincata	13	M6	100
65489.01700.00	zincata	17	M6	100
65489.02000.00	zincata	20	M6	100
65489.02400.00	zincata	24	M6	100
65490.01500.00	zincata	15	M8	100
65490.02000.00	zincata	20	M8	100
65490.02400.00	zincata	24	M8	100



Bussola

Materiale: Zama

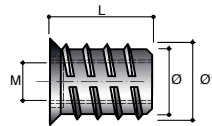

CODICE	FINITURA	MISURE mm				BOX
		Ø	Ø1	L	M	
65489Z01000.00	Grezzo	8	9,5	10	M6	100
65489Z01300.00	Grezzo	8	9,5	13	M6	100
65489Z01500.00	Grezzo	8	9,5	15	M6	100
65489Z01700.00	Grezzo	8	9,5	17	M6	100
65489Z02000.00	Grezzo	8	9,5	20	M6	100
65490Z01500.00	Grezzo	10	12	15	M8	100
65490Z02000.00	Grezzo	10	12	20	M8	100
65491Z01800.00	Grezzo	12	15	18	M10	100



Bussola

Materiale: Ottone

CODICE	FINITURA	MISURE mm	BOX
65091.01000.40	Ottonata	diam. 7 - FIL.M5 - L. 9	100
65091.01000.04	Bronzata	diam. 7 - FIL.M5 - L. 9	100
65091.01000.32	Nichelata	diam. 7 - FIL.M5 - L. 9	100



Bussola esagonale

Materiale: Ottone

CODICE	FINITURA	MISURE mm	BOX
65494.00900.40	Ottone	FIL.M4 - L. 9	500
65495.00900.40	Ottone	FIL.M5 - L. 9	500





Bussola esagonale con sfera ch.8

Materiale: Ottone

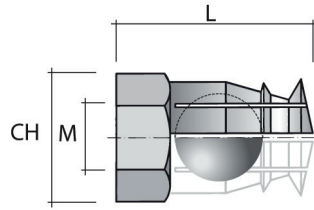

CODICE	MISURE mm			BOX
	CH	L	M	
BU120L	8	12	M6	100

Bussola esagonale senza sfera ch.8

Materiale: Ottone

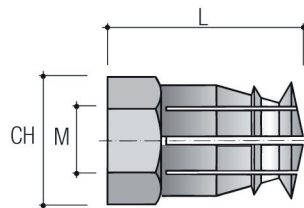

CODICE	MISURE mm			BOX
	CH	L	M	
BU550L	8	9	M6	100

Bussola esagonale senza sfera ch.5,

Materiale: Ottone

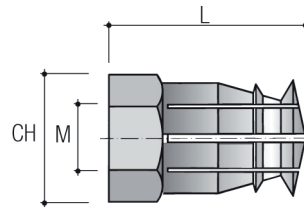

CODICE	MISURE mm			BOX
	CH	L	M	
BU240L	5,5	10	M4	100

Bussola esagonale con sfera ch.5,5

Materiale: Ottone

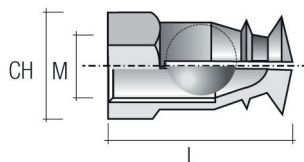

CODICE	MISURE mm			BOX
	CH	L	M	
BU570L	5,5	10	M4	100

Fermacassetto

Materiale: Plastica

CODICE	COLORE	BOX
49001.03500.00	Bianco	100

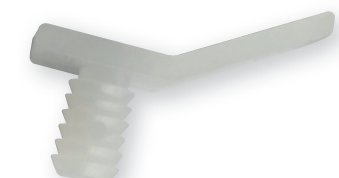
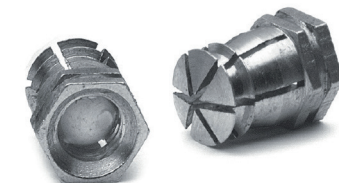
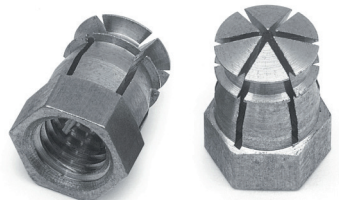
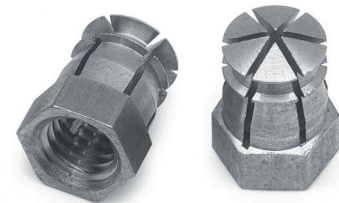
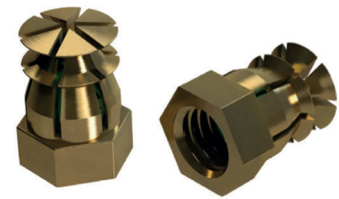

# INDICE

## codice completo

CODICE	PAG.
10.06.502	37
10.A2S17642	37
10.A2S17742	37
10.A2S18142	37
15232Z12800.07	7
15232Z12800.19	7
15232Z16000.07	7
15232Z16000.19	7
15245Z12800.19	7
15245Z12800.DT	7
15246Z12800.36	7
15246Z12800.83	7
15247Z12800.DT	8
15247Z12800.N2	8
15247Z16000.DT	8
15247Z16000.N2	8
15248Z12800.32	8
15248Z12800.83	8
15ME.001300.00	43
2090400.0524	36
2090400.5075	37
2092400.0524	36
2092400.5075	37
2095400.0524	36
2095400.5075	37
21.19F5.0524	36
21.19F5.5075	37
24232Z03000.07	7
24232Z03000.19	7
24245Z05000.19	7
24245Z05000.DT	7
24246Z05000.36	7
24246Z05000.83	7
24247Z05000.DT	8
24247Z05000.N2	8
24248Z05000.32	8
24248Z05000.83	8
24415Z01500.36	8
24415Z01500.DT	8
24415Z02000.36	8
24415Z02000.DT	8
24415Z02500.36	8
24415Z02500.DT	8
24VP.001024.96	10
24VP.001024.F1	10
24VP.001024.N2	10
24VP.001050.96	10

CODICE	PAG.
24VP.001050.F1	10
24VP.001050.N2	10
39013.02000.05	22
39013.02000.27	22
39013.02500.05	22
39013.02500.27	22
39027.00800.04	23
39027.00800.17	23
39027.00800.32	23
39027.01000.04	23
39027.01000.17	23
39027.01000.32	23
39027.01200.04	23
39027.01200.17	23
39027.01200.32	23
39027.01400.04	23
39027.01400.17	23
39027.01400.32	23
39028.10000.33C	25
39039Z015D0.04	22
39039Z015D0.17	22
39039Z015D0.32	22
39039Z015S0.04	22
39039Z015S0.17	22
39039Z015S0.32	22
39039Z020D0.04	22
39039Z020D0.17	22
39039Z020D0.32	22
39039Z020S0.04	22
39039Z020S0.17	22
39039Z020S0.32	22
39039Z025D0.04	22
39039Z025D0.17	22
39039Z025D0.32	22
39039Z025S0.04	22
39039Z025S0.17	22
39039Z025S0.32	22
39039Z030D0.04	22
39039Z030D0.17	22
39039Z030D0.32	22
39039Z030S0.04	22
39039Z030S0.17	22
39039Z030S0.32	22
39040.01500.04	22
39040.01500.17	22
39040.01500.32	22
39040.020D0.04	22

CODICE	PAG.
39040.020D0.17	22
39040.020D0.32	22
39040.020S0.04	22
39040.020S0.17	22
39040.020S0.32	22
39078.04800.F1	19
39078.04800.G1	19
39078.08700.F1	19
39078.08700.G1	19
39085.03200.DC	19
39086.04400.04	19
39086.04400.32	19
39086.04400.66	19
39086.04900.04	19
39086.04900.32	19
39086.04900.66	19
39086.06000.04	19
39086.06000.32	19
39086.06000.66	19
39087.03300.F1	19
39087.03300.G1	19
39132.12000.F1	21
39132.12000.P2	21
39132.12001.F1	21
39132.12001.P2	21
39133.00000.83	20
39133.00000.F1	20
39133.00000.P2	20
39133.00001.83	20
39133.00001.F1	20
39133.00001.P2	20
39133.000BS.83	20
39133.000BS.F1	20
39133.000BS.P2	20
39134.03500.33	25
39135.03300.33	25
39136.04900.33	25
39143.12000.83	21
39143.12000.F1	21
39143.12000.P2	21
39143.12001.83	21
39143.12001.F1	21
39143.12001.P2	21
41003.30000.G1	47
41003.30001.G1	47
41003.50000.G1	47
41003.50001.G1	47

CODICE	PAG.
41007Z06400.21	63
41007Z08400.21	63
41009.09500.33	50
41009.12000.33	50
41009.15000.33	50
41010.08000.21	50
41010.10000.21	50
41010.12000.21	50
41010.14000.21	50
41010.16000.21	50
41011.12000.64	50
41012Z04000.17	19
41015.03000.00	30
41015.0300E.00	30
41015.03500.00	30
41015.04000.00	30
41016.02500.00	30
41016.03000.00	30
41016.0300E.00	30
41016.03500.00	30
41016.0350E.00	30
41016.04000.00	30
41016.0400E.00	30
41017.03000.00	30
41017.0300E.00	30
41017.03500.00	30
41017.04000.00	30
41017.0400E.00	30
41017.05000.00	30
41018.00600.00	30
41018.00800.00	30
41018.01000.00	30
41018.01200.00	30
41018.01400.00	30
41023.13300.33	25
41027.01000.00	30
41027.02000.00	30
41044.00000.P1	53
41045.00000.P1	53
41046.00000.64	50
41047.15000.33	50
41048.14000.64	50
41056.19000.P1	47
41065.07600.P1	53
41069.09000.00	13
42003.C3102.00	30
42006.C0901.00	29
42006.C1001.00	29
42006.C1002.00	29
42006.C1101.00	29
42006.C1201.00	29
42006.C1202.00	29
42006.C1301.00	29
42006.C1401.00	29
42006.C1501.00	29
42006.C3001.00	29
42006.C3002.00	29

CODICE	PAG.
42008.C1000.32	44
42008.C1000.F1	44
42008.C1000.G1	44
42008.C1025.32	44
42008.C1500.32	44
42008.C1500.F1	44
42008.C1500.G1	44
42008.C1525.32	44
42008.C3000.32	44
42008.C3025.32	44
42008.C3030.32	44
42014Z01500.32C	44
42015.03000.00	29
42016Z01800.32	45
42016Z02500.32	45
42020.07600.00	29
42022.01500.04	53
42022.01500.17	53
42022.01500.32	53
42022.02000.04	53
42022.02000.17	53
42022.02000.32	53
42022.02400.04	53
42022.02400.17	53
42022.02400.32	53
42022.03000.04	53
42022.03000.17	53
42022.03000.32	53
42023.01000.04	54
42023.01000.17	54
42023.01000.32	54
42023.02000.04	54
42023.02000.17	54
42023.02000.32	54
42023.02500.04	54
42023.02500.17	54
42023.02500.32	54
42023.03000.04	54
42023.03000.17	54
42023.03000.32	54
42024.08000.00	29
42025.07600.00	29
42055.C1001.32	44
42055.C1002.32	44
42055.C1501.32	44
42055.C3001.32	44
42055.C3002.32	44
42056Z03000.32	45
42057Z03000.32	45
42062.01200.F1	56
42062.01200.G1	56
42062.01200.P1	56
42119Z01800.32	45
42119Z02500.32	45
42124Z03200.32	44
42126.146D0.F1	34
42126.146D0.G1	34

CODICE	PAG.
42126.146S0.F1	34
42126.146S0.G1	34
42127.000D0.F1	34
42127.000S0.F1	34
42129Z0300A.32	45
42129Z0300C.32	45
42130Z01800.32	46
42130Z01801.32	46
42130Z02500.32	46
42130Z02501.32	46
42131.00000.F1	46
42131.00000.G1	46
42132.05000.F1	46
42132.05000.G1	46
43245Z14000.34	11
43245Z14000.36	11
44339.00000.32	34
44340.00000.32	34
46005.07000.04	21
46005.07000.64	21
46006.08000.03	21
46006.08000.05	21
46006.08000.27	21
48015.02500.04	16
48015.02500.32	16
48015.02500.40	16
48015.03000.04	16
48015.03000.32	16
48015.03000.40	16
48015.03025.04	16
48015.03025.32	16
48015.03025.40	16
48015.03500.04	16
48015.03500.32	16
48015.03500.40	16
48015.03530.04	16
48015.03530.32	16
48015.03530.40	16
48015.04000.04	16
48015.04000.32	16
48015.04000.40	16
48015.04030.04	16
48015.04030.32	16
48015.04030.40	16
48015.04035.04	16
48015.04035.32	16
48015.04035.40	16
48015.05000.04	16
48015.05000.32	16
48015.05000.40	16
48015.05030.04	16
48015.05030.32	16
48015.05030.40	16
48015.05040.04	16
48015.05040.32	16
48015.05040.40	16
48015.06040.04	16

CODICE	PAG.
48015.06040.32	16
48015.06040.40	16
48015.06050.04	16
48015.06050.32	16
48015.06050.40	16
48015.07055.04	16
48015.07055.32	16
48015.07055.40	16
48021.01000.40	15
48021.01200.40	15
48021.01400.40	15
48021.01600.40	15
48021.01800.40	15
48022.04000.03	17
48022.04000.04	17
48022.04000.40	17
48023.00800.03	17
48023.00800.04	17
48023.00800.40	17
48023.01000.03	17
48023.01000.04	17
48023.01000.40	17
48023.01300.03	17
48023.01300.04	17
48023.01300.40	17
48024.08000.17	18
48024.08000.32	18
48024.08000.64	18
48025.08000.04	17
48025.08000.32	17
48025.08000.40	17
48028.08500.03	15
48028.08500.05	15
48028.08500.27	15
48033.08800.03	14
48033.08800.05	14
48033.08800.27	14
48084Z04000.05	13
48098.01200.03	14
48098.01200.05	14
48098.01200.27	14
48224.04000.04	14
48224.04001.04	14
48245Z01800.04	13
48245Z01800.10	13
48245Z02400.04	13
48245Z02400.10	13
48246Z06200.04	13
48246Z06200.10	13
48247Z05000.04	13
48247Z05000.10	13
48248Z07000.04	13
48248Z07000.10	13
48249Z08000.04	14
48249Z08000.10	14
48249Z10500.04	14
48249Z10500.10	14

CODICE	PAG.
48250Z07500.04	14
48250Z07500.10	14
48251Z05200.04	14
48251Z05200.10	14
48252.03030.17	18
48252.03030.33	18
48252.04035.17	18
48252.04035.33	18
48252.04040.17	18
48252.04040.33	18
48252.05040.17	18
48252.05040.33	18
48252.05050.17	18
48252.05050.33	18
48252.06050.17	18
48252.06050.33	18
48252.07055.17	18
48252.07055.33	18
48254.03000.17	18
48254.03000.33	18
48254.04000.17	18
48254.04000.33	18
48254.05000.17	18
48254.05000.33	18
48254.06000.17	18
48254.06000.33	18
48254.07000.17	18
48254.07000.33	18
48255.04000.33	18
48255.05000.33	18
48255.06000.33	18
48255.08000.33	18
48255.10000.33	18
48255.12000.33	18
48255.14000.33	18
48255.16000.33	18
48256.03535.04	15
48256.03535.40	15
48256.04035.04	15
48256.04035.40	15
48256.04040.04	15
48256.04040.40	15
48256.05040.04	15
48256.05040.40	15
48256.05050.04	15
48256.05050.40	15
48256.06050.04	15
48256.06050.40	15
48256.07055.04	15
48256.07055.40	15
48257.04000.04	17
48257.04000.40	17
48258.04000.03	17
48258.04000.04	17
48258.04000.40	17
48260.06600.04	14
48260.06600.17	14

CODICE	PAG.
48260.06600.DC	14
48260.08000.04	14
48260.08000.17	14
48260.08000.DC	14
48267.11100.05	15
48267.15100.05	15
48268.10400.05	15
48268.14500.05	15
48269.07000.05	15
48269.09600.05	15
48270.00000.32	12
48270.00001.32	12
48270.00002.32	12
48270.00004.32	12
49001.03500.00	65
49007.06000.F1	25
49007.06000.G1	25
49007.06000.P1	25
49007.06000.P2	25
49015.08600.33	34
49016.04700.33	34
49020.01500.04	24
49020.01500.17	24
49020.01500.32	24
49020.02000.04	24
49020.02000.17	24
49020.02000.32	24
49020.02500.04	24
49020.02500.17	24
49020.02500.32	24
49020.03000.04	24
49020.03000.17	24
49020.03000.32	24
49162.C2000.00	43
49162.C2000.04	43
49162.C3000.00	43
49162.C3000.04	43
49163.15000.32	24
49163.15000.64	24
49163.20000.32	24
49163.20000.64	24
49163.25000.32	24
49163.25000.64	24
49163.30000.32	24
49163.30000.64	24
49164.100D0.17	24
49164.100D0.32	24
49164.100S0.17	24
49164.100S0.32	24
49164.150D0.17	24
49164.150D0.32	24
49164.150S0.17	24
49164.150S0.32	24
49164.200D0.17	24
49164.200D0.32	24
49164.200S0.17	24
49164.200S0.32	24

CODICE	PAG.
49164.250D0.17	24
49164.250D0.32	24
49164.250S0.17	24
49164.250S0.32	24
49164.300D0.17	24
49164.300D0.32	24
49164.300S0.17	24
49164.300S0.32	24
49169.C3000.00	47
49169.C3000.P1	47
49190.00000.00	38
49190.00000.F1	38
49190.00000.P1	38
49191.00000.00	38
49191.00000.F1	38
49191.00000.P1	38
49192.00000.00	38
49192.00000.F1	38
49192.00000.P1	38
49193.00000.00	38
49193.00000.F1	38
49193.00000.P1	38
49194.04000.P1	35
50076.00000.04	23
50076.00000.17	23
50076.00000.32	23
50081.00500.04	23
50081.00500.10	23
50081.01800.04	23
50081.01800.10	23
50082.06000.04	23
50082.06000.10	23
50082.08000.04	23
50082.08000.10	23
50082.10000.04	23
50082.10000.10	23
5066400PVC.0524	36
5066400PVC.5075	37
5069.400.PL00D	35
51.09.565AV	37
51.09.565GR	35
51.09.565NR	36
52028.C2150.F1	46
52028.C2150.G1	46
52028.C2150.P1	46
52028.C2150.P2	46
52028.C2151.F1	46
52028.C2151.G1	46
52028.C2151.P1	46
52028.C2151.P2	46
52028.C2600.F1	46
52028.C2600.P1	46
52028.C2601.F1	46
52028.C2601.P1	46
52068.C1850.F1	43
52068.C1850.G1	43
52068.C2050.F1	43

CODICE	PAG.
52068.C2050.G1	43
52068.C2250.F1	43
52068.C2250.G1	43
52069.00000.F1	43
52069.00000.G1	43
52070.C2000.F1	43
52070.C2000.G1	43
52070.C3000.F1	43
52070.C3000.G1	43
52071.00000.04	43
52071.00000.33	43
52072.C2000.F1	43
52072.C2000.G1	43
52072.C3000.F1	43
52072.C3000.G1	43
52077.00900.F1	47
52077.00900.G1	47
52077.00900.P1	47
52077.00900.P2	47
52077.01300.P1	47
52077.01300.P2	47
52088.02500.33	39
52088.03000.33	39
52088.03500.33	39
52088.04000.33	39
52088.04500.33	39
52088.05000.33	39
52088.05500.33	39
52088.06000.33	39
52089.03000.33	39
52089.03500.33	39
52089.04000.33	39
52089.04500.33	39
52089.05000.33	39
52089.05500.33	39
52089.06000.33	39
52090.02500.33	40
52090.03000.33	40
52090.03500.33	40
52090.04000.33	40
52090.04500.33	40
52090.05000.33	40
52090.05500.33	40
52090.06000.33	40
52090.06000.33	40
52093.C2000.00	43
52093.C3000.00	43
53152.10000.F1	26
53152.10000.P1	26
53152.15000.F1	26
53152.15000.P1	26
53152.20000.F1	26
53152.20000.P1	26
53152.25000.F1	26
53152.25000.P1	26
53152.30000.F1	26
53152.30000.P1	26
53152.35000.F1	26

CODICE	PAG.
53152.35000.P1	26
53152.40000.F1	26
53152.40000.P1	26
53152.70000.F1	26
53152.70000.P1	26
53152.80000.F1	26
53152.80000.P1	26
53153.00000.P1	26
53153.10000.F1	26
53153.10000.P1	26
53153.15000.F1	26
53153.15000.P1	26
53153.20000.F1	26
53153.20000.P1	26
53153.25000.F1	26
53153.25000.P1	26
53153.30000.F1	26
53153.30000.P1	26
53153.35000.F1	26
53153.35000.P1	26
53153.40000.F1	26
53153.40000.P1	26
53153.70000.F1	26
53153.70000.P1	26
53153.80000.F1	26
53153.80000.P1	26
53161.16000.P1	47
53184.08000.00	35
53184.08000.F1	35
53184.08000.P1	35
53184.10000.00	35
53184.10000.F1	35
53184.10000.P1	35
55038.00500.00	28
55038.00700.00	28
55038.00800.00	28
55038.01200.00	28
55039.00800.00	28
55039.01100.00	28
55039.01700.00	28
55039.01900.00	28
55042.01900.00	28
55042.02200.00	28
55042.03000.00	28
55042.03700.00	28
55044.01300.00	28
55044.01700.00	28
55044.02300.00	28
55166.01600.00	28
55166.02300.00	28
55166.03300.00	28
55166.04000.00	28
55176.02600.00	28
65028.00600.33	25
65028.00800.33	25
65028.01000.33	25
65091.01000.04	64

CODICE	PAG.
65091.01000.32	64
65091.01000.40	64
65489.01300.00	59 – 64
65489.01700.00	59 – 64
65489.02000.00	59 – 64
65489.02400.00	59 – 64
65489Z01000.00	59 – 64
65489Z01300.00	59 – 64
65489Z01500.00	59 – 64
65489Z01700.00	59 – 64
65489Z02000.00	59 – 64
65490.01500.00	64
65490.02000.00	64
65490.02400.00	64
65490Z01500.00	64
65490Z02000.00	64
65491Z01800.00	64
65493.01000.00	64
65494.00900.40	64
65495.00900.40	64
81.G1.1001	38
BARRA.T120	49
BARRA.T160	49
BARRA.T180	49
BARRA.T80	49
BARRA.T90	49
BO01ZBR	60
BO01ZBR.2000	60
BO01ZZ	60
BO01ZZ.2000	60
BO03ZBR	61
BO03ZZ	61
BO07ZBR	60
BO07ZBR.2000	60
BO07ZZ	60
BO07ZZ.2000	60
BO08ZBR	60
BO08ZBR.2000	60
BO08ZZ	60
BO08ZZ.2000	60
BO09ZBR	60
BO09ZBR.2000	60
BO09ZZ	60
BO09ZZ.2000	60
BO10ZBR	60
BO10ZBR.2000	60
BO10ZZ	60
BO10ZZ.2000	60
BO11ZBR	60
BO11ZBR.2000	60
BO11ZZ	60
BO11ZZ.2000	60
BO13ZBR	61
BO13ZZ	61
BO30ZBR	60
BO30ZZ	60
BO31ZBR	60

CODICE	PAG.
B031ZBR.2000	60
B031ZZ	60
B031ZZ.2000	60
B082ZZ	59
B082ZZ.1000	59
B083ZZ	59
B083ZZ.1000	59
BU09PN	63
BU09PN.5000	63
BU10PN	63
BU10PN.5000	63
BU120L	65
BU17PN	63
BU240L	65
BU550L	65
BU570L	65
BU61PN	63
BU61PN.5000	63
CF04PB	58
CF04PCI	58
CF04PNE	58
CF06PB	59
CF06PMA	59
CF135PB	63
CF136PB	62 – 63
CF136PMA	62
CF136PNE	62
CF80PAC	59
CF80PB	59
CF80PMA	59
CF80PNE	59
EC20ZZ	58
EC20ZZ.2000	58
EC30ZZ	58
EC30ZZ.2000	58
EC40ZL	62
FPG004MG39950	34
FPG004MG39951	34
FPG004MG39952	34
FPG004MG39953	34
FPG004MG39955	34
FPR002MG39934	41
FPR002MG39935	41
FPR002MG39936	41
FPR002MG39937	41
FPR002MG39938	41
FPR002MG39939	41
FPR002MG39940	41
FPR002MG39941	41
FPR002MG39942	41
FPR002MG39943	41
FPR002MG39944	41
FPR002MG39945	41
FPR002MG39946	41
FPR002MG39947	41
FPR002MG39948	41
FPR002MG39949	41

CODICE	PAG.
GN56MG43784	11
GR01ZBR	60
GR01ZBR.2000	60
GR01ZZ	60
GR01ZZ.2000	60
GR05ZBR	61
GR05ZZ	61
GR08ZBR	60
GR08ZBR.2000	60
GR08ZZ	60
GR08ZZ.2000	60
GR09ZBR	60
GR09ZBR.2000	60
GR09ZZ	60
GR09ZZ.2000	60
GS86MG43774	10
GS86MG43775	10
GS86MG43776	10
GS86MG43777	10
GU07MG45037	9
GU07MG45038	9
ME03ZNL	54
ME08FZ	53
ME08FZ.5000	53
ME64ZNL	54
ME65ZNL	54
MEC.A120	49
MEC.A140-160	49
MEC.A180	49
MEC.A80-90	49
MEC.T120	49
MEC.T140-180	49
MEC.T80/90	49
MV08ZBR	55
MV08ZNL	55
MV08ZO	55
MV09ZBR	55
MV09ZNL	55
MV09ZO	55
MV33ZNL	55
MV33ZNN	55
MV34ZNL	55
MV34ZNN	55
MV64ZNL	55
PB15KT700017	33
PB15KT700018	33
PB15KT700019	33
PB15KT700020	33
PI.D50H30	49
PI.D50H35	49
PI.D50H40	49
RE.L120190	49
RE.L120195	49
RE.L120200	49
RE.L80190	49
RE.L80195	49
RE.L80200	49

CODICE	PAG.
RE.L90190	49
RE.L90195	49
RE.L90200	49
RE.P160190	49
RE.P160195	49
RE.P160200	49
RE.P180190	49
RE.P180195	49
RE.P180200	49
RE29MG45043	9
RE29MG45044	9
RE29MG45045	9
RE29MG45046	9
RE29MG45047	9
RE29MG45048	9
RE29MG45049	9
RE29MG45050	9
RE29MG45051	9
RE29MG45052	9
RE29MG45053	9
RE29MG45054	9
RT30PGA	46
SCOLA.600	35
SCOLA.800	35
SCOLA.900	35
SI01PB	57
SI01PMA	57
SI01PNE	57
SI02PB	57
SI02PMA	57
SI02PNE	57
SO051PGR	56
SO061ZNL	56
SP01FZ	57
ST01ZBR	57
ST01ZNL	57
ST01ZNL.2000	57
ST13ZBR	57
ST13ZNL	57
ST13ZNL.2000	57
TE03FZ	58
TE04FZ	58
TE135FZ	62
TE137FZ	62
TF02FZ	60
TF02FZ.2000	60
TF04FZ	60
TF04FZ.1000	60
TF06FZ	61
TF08FZ	61
TF80FZ	59
TF80FZ.2000	59
TF81FZ	59
TF81FZ.1500	59
TF82FZ	59
TF82FZ.1000	59
TM01FZ	58

CODICE	PAG.
TM01FZ.2000	58
TM02FZ	58
TM02FZ.2500	58
TM03FZ	58
TM03FZ.2000	58
TM04FZ	58
TM04FZ.2500	58
UA130MG45039	9
UA130MG45040	9
UA131MG45041	9
UA131MG45042	9
US10MG23722	11
US10MG23723	11
US10MG23724	11
US10MG40252	11
US10MG40253	11
US10MG41745	11
US10MG41746	11
US10MG43760	11
US10MG43761	11
UU16MG43778	11
UU16MG43779	11
UU16MG43780	11
UU17MG45031	9
UU17MG45032	9
UU17MG45033	9
UU17MG45034	9
UU17MG45035	9
UU17MG45036	9
UU56MG43781	11
UU56MG43782	11
UU56MG43783	11
UU86MG43762	10
UU86MG43763	10
UU86MG43764	10
UU86MG43765	10
UU86MG43766	10
UU86MG43767	10
UU86MG43768	10
UU86MG43769	10
UU86MG43770	10
UU86MG43771	10
UU86MG43772	10
UU86MG43773	10
VC01FBR	52
VC01FNL	52
VC01FNL.5000	52
VC02FBR	52
VC02FNL	52
VC02FNL.5000	52
VC03FBR	52
VC03FNL	52
VC03FNL.4000	52
VC04FBR	52
VC04FNL	52
VC05FBR	52
VC05FNL	52

CODICE	PAG.
VC05FNL.3000	52
VC06FBR	52
VC06FNL	52
VC06FNL.2500	52
VC07FBR	52
VC07FNL	52
VC07FNL.2000	52
VC08FBR	52
VC08FNL	52
VC11FBR	52
VC11FNL	52
VC11FNL.2500	52
VE01FZ	56 - 57
VE01FZ.2000	56 - 57
VE02FZ	56 - 57
VE02FZ.2000	56 - 57
VE03FZ	56 - 57
VE03FZ.2000	56 - 57
VF01FBR	52
VF01FNL	52
VF01FNL.2000	52
VF03FBR	52
VF03FNL	52
VF03FNL.1500	52
VF04FBR	52
VF04FNL	52
VF04FNL.2000	52

# INDICE

## codice breve

COD.BREVE	PAG.	COD.BREVE	PAG.	COD.BREVE	PAG.	COD.BREVE	PAG.	COD.BREVE	PAG.
MG10161	47	MG11627	16	MG30633	46	MG42085	28	MG42672	19
MG10163	47	MG11628	16	MG30634	46	MG42086	28	MG42679	44
MG10170	63	MG11629	16	MG32517	23	MG42087	28	MG42680	44
MG10171	63	MG11630	16	MG35913	37	MG42088	28	MG42681	21
MG43229	50	MG11649	15	MG35914	37	MG42089	28	MG42682	21
MG43230	50	MG11650	15	MG35915	37	MG42091	28	MG42683	21
MG43231	50	MG11651	15	MG35923	23	MG42092	28	MG42684	21
MG10175	50	MG11652	17	MG36048	46	MG42093	28	MG42685	26
MG10176	50	MG11653	17	MG37563	22	MG42099	28	MG42686	26
MG10177	50	MG11654	17	MG37564	22	MG42322	44	MG42687	26
MG10179	19	MG11655	17	MG38569	35	MG42461	29	MG42688	26
MG10183	30	MG11656	17	MG38571	38	MG42538	15	MG42689	26
MG10184	30	MG11657	17	MG39614	44	MG42539	19	MG42690	26
MG10185	30	MG11658	17	MG39934	41	MG42540	19	MG42691	26
MG10186	30	MG11659	17	MG39935	41	MG42541	19	MG42692	26
MG10187	30	MG11660	17	MG39936	41	MG42542	19	MG42693	26
MG10188	30	MG11661	17	MG39937	41	MG42543	19	MG42694	26
MG10189	30	MG11662	17	MG39938	41	MG42544	19	MG42695	26
MG10191	30	MG11663	18	MG39939	41	MG42545	19	MG42696	26
MG10192	30	MG11664	17	MG39940	41	MG42562	13	MG42697	26
MG10193	30	MG11670	15	MG39941	41	MG42563	13	MG42698	26
MG10194	30	MG11684	14	MG39942	41	MG42565	13	MG42699	26
MG10195	30	MG11685	14	MG39943	41	MG42566	13	MG42700	26
MG10196	30	MG11687	14	MG39944	41	MG42568	13	MG42701	26
MG10197	30	MG11928	13	MG39945	41	MG42569	13	MG42702	26
MG10198	30	MG11968	14	MG39946	41	MG42570	13	MG42703	26
MG10199	30	MG11969	14	MG39947	41	MG42571	13	MG42704	26
MG10216	25	MG11971	14	MG39948	41	MG42572	13	MG42705	26
MG10222	30	MG12333	25	MG39949	41	MG42573	13	MG42706	26
MG10223	30	MG12334	25	MG39950	34	MG42574	14	MG42707	26
MG10311	44	MG12363	34	MG39951	34	MG42575	14	MG42708	26
MG10312	29	MG12364	34	MG39952	34	MG42576	14	MG42709	26
MG10319	29	MG12370	24	MG39953	34	MG42577	14	MG42710	26
MG10335	29	MG12897	28	MG39995	34	MG42578	14	MG42711	26
MG10337	29	MG12898	28	MG40252	11	MG42579	14	MG42712	26
MG11457	21	MG12899	28	MG40253	11	MG42580	14	MG42713	26
MG11458	21	MG12900	28	MG40994	36	MG42581	14	MG42714	26
MG11459	21	MG12911	28	MG41236	7	MG42586	43	MG42715	26
MG11461	21	MG23722	11	MG41237	7	MG42587	43	MG42716	26
MG11620	16	MG23723	11	MG41238	7	MG42588	43	MG42717	26
MG11621	16	MG23724	11	MG41239	7	MG42589	34	MG42718	26
MG11622	16	MG28721	14	MG41745	11	MG42590	34	MG42719	26
MG11623	16	MG29775	14	MG41746	11	MG42591	43	MG42720	26
MG11624	16	MG30210	44	MG42082	28	MG42592	43	MG42722	26
MG11625	16	MG30211	45	MG42083	28	MG42593	43	MG42723	15
MG11626	16	MG30212	45	MG42084	28	MG42671	19	MG42724	15



COD.BREVE	PAG.	COD.BREVE	PAG.	COD.BREVE	PAG.	COD.BREVE	PAG.	COD.BREVE	PAG.
MG42725	47	MG42902	46	MG42979	16	MG43048	18	MG43104	44
MG42726	47	MG42903	46	MG42980	16	MG43049	18	MG43105	50
MG42737	34	MG42904	46	MG42981	16	MG43050	18	MG43106	50
MG42738	34	MG42915	22	MG42982	16	MG43051	24	MG43107	50
MG42739	43	MG42916	22	MG42983	16	MG43052	24	MG43108	50
MG42740	43	MG42917	22	MG42984	16	MG43053	24	MG43109	50
MG42741	43	MG42918	22	MG42985	16	MG43054	24	MG43110	50
MG42742	43	MG42919	22	MG42986	16	MG43055	24	MG43378	45
MG42743	43	MG42920	22	MG42988	16	MG43056	24	MG43379	45
MG42848	29	MG42921	22	MG42990	16	MG43057	24	MG43409	44
MG42853	46	MG42922	22	MG42992	16	MG43058	24	MG43414	29
MG42854	46	MG42923	22	MG42993	16	MG43059	24	MG43415	29
MG42856	43	MG42924	22	MG42995	16	MG43060	24	MG43416	29
MG42857	18	MG42925	22	MG42996	16	MG43061	24	MG43417	29
MG42858	18	MG42926	22	MG42998	16	MG43062	24	MG43418	29
MG42859	18	MG42927	22	MG42999	16	MG43063	24	MG43419	29
MG42860	18	MG42928	22	MG43000	16	MG43064	24	MG43420	29
MG42861	18	MG42929	22	MG43001	15	MG43065	24	MG43421	29
MG42862	18	MG42930	22	MG43002	15	MG43066	24	MG43422	29
MG42863	18	MG42934	22	MG43003	15	MG43067	24	MG43424	28
MG42864	18	MG42935	22	MG43004	15	MG43068	24	MG43425	28
MG42865	18	MG42936	22	MG43005	15	MG43069	24	MG43426	45
MG42866	18	MG42937	22	MG43006	15	MG43070	24	MG43427	45
MG42867	18	MG42938	22	MG43007	15	MG43071	24	MG43428	28
MG42868	18	MG42939	22	MG43015	15	MG43072	24	MG43455	30
MG42869	18	MG42940	22	MG43016	15	MG43073	24	MG43592	21
MG42870	18	MG42942	23	MG43017	15	MG43074	24	MG43603	47
MG42871	19	MG42943	23	MG43018	15	MG43075	24	MG43699	47
MG42872	19	MG42944	23	MG43019	15	MG43076	24	MG43760	11
MG42873	19	MG42952	23	MG43020	15	MG43077	24	MG43761	11
MG42874	46	MG42953	23	MG43021	15	MG43078	24	MG43762	10
MG42875	46	MG42954	23	MG43022	17	MG43079	24	MG43763	10
MG42876	47	MG42955	23	MG43024	17	MG43080	24	MG43764	10
MG42877	20	MG42956	23	MG43025	17	MG43081	24	MG43765	10
MG42878	20	MG42957	23	MG43026	17	MG43082	24	MG43766	10
MG42879	20	MG42958	14	MG43027	17	MG43083	24	MG43767	10
MG42880	20	MG42959	14	MG43028	17	MG43084	24	MG43768	10
MG42881	20	MG42960	14	MG43029	17	MG43085	24	MG43769	10
MG42882	20	MG42961	14	MG43030	17	MG43086	24	MG43770	10
MG42883	43	MG42962	14	MG43031	18	MG43087	24	MG43771	10
MG42884	43	MG42963	14	MG43032	18	MG43088	24	MG43772	10
MG42885	43	MG42964	15	MG43033	18	MG43089	24	MG43773	10
MG42886	43	MG42965	16	MG43034	18	MG43090	25	MG43774	10
MG42887	43	MG42966	16	MG43035	18	MG43091	25	MG43775	10
MG42888	43	MG42967	16	MG43036	18	MG43092	25	MG43776	10
MG42889	43	MG42968	16	MG43037	18	MG43093	25	MG43777	10
MG42890	43	MG42969	16	MG43038	18	MG43094	25	MG43778	11
MG42891	43	MG42970	16	MG43039	18	MG43095	34	MG43779	11
MG42892	43	MG42971	16	MG43040	18	MG43096	34	MG43780	11
MG42893	43	MG42972	16	MG43041	18	MG43097	44	MG43781	11
MG42896	20	MG42973	16	MG43042	18	MG43098	44	MG43782	11
MG42897	20	MG42974	16	MG43043	18	MG43099	44	MG43783	11
MG42898	20	MG42975	16	MG43044	18	MG43100	44	MG43784	11
MG42899	45	MG42976	16	MG43045	18	MG43101	44	MG43882	47
MG42900	45	MG42977	16	MG43046	18	MG43102	44	MG43883	47
MG42901	46	MG42978	16	MG43047	18	MG43103	44	MG43884	47

COD.BREVE	PAG.	COD.BREVE	PAG.	COD.BREVE	PAG.	COD.BREVE	PAG.	COD.BREVE	PAG.
MG43885	47	MG44727	30	MG45054	9	MG45682	40	MG9664	19
MG43886	47	MG44728	30	MG45092	49	MG45683	40	MG9678	19
MG43887	46	MG44729	30	MG45093	49	MG45684	40	MG9679	19
MG43888	46	MG44740	7	MG45094	49	MG45685	25	MG9680	19
MG43889	46	MG44741	7	MG45095	49	MG45686	25	RT30PGA	46
MG43890	46	MG44742	7	MG45096	49	MG45687	25		
MG43891	46	MG44743	7	MG45097	49	MG45706	36		
MG43892	46	MG44744	7	MG45098	49	MG45707	36		
MG43893	46	MG44745	7	MG45099	49	MG45708	36		
MG43894	46	MG44746	7	MG45100	49	MG45709	36		
MG43931	47	MG44747	7	MG45101	49	MG45717	37		
MG43932	46	MG44748	7	MG45102	49	MG45809	36		
MG44030	15	MG44749	7	MG45103	49	MG46102	35		
MG44031	15	MG44750	8	MG45104	49	MG46103	35		
MG44032	15	MG44751	8	MG45105	49	MG46104	35		
MG44033	15	MG44752	8	MG45106	49	MG46105	35		
MG44034	15	MG44753	8	MG45107	49	MG46106	35		
MG44035	15	MG44776	8	MG45108	49	MG46107	35		
MG44252	21	MG44777	8	MG45109	49	MG46108	38		
MG44253	21	MG44778	8	MG45110	49	MG46109	38		
MG44254	21	MG44779	8	MG45111	49	MG46110	38		
MG44255	21	MG44780	8	MG45112	49	MG46111	38		
MG44256	21	MG44781	8	MG45113	49	MG46112	38		
MG44257	21	MG44782	8	MG45114	49	MG46113	38		
MG44259	34	MG44783	8	MG45115	49	MG46114	38		
MG44260	34	MG44784	8	MG45116	49	MG46115	38		
MG44261	35	MG44785	8	MG45117	49	MG46116	38		
MG44262	35	MG44786	8	MG45118	49	MG46117	38		
MG44263	35	MG44787	8	MG45119	49	MG46118	38		
MG44264	12	MG44904	37	MG45120	49	MG46119	38		
MG44265	12	MG44905	37	MG45121	49	MG46127	33		
MG44266	12	MG44974	37	MG45184	10	MG46128	33		
MG44267	12	MG44984	37	MG45324	53	MG46129	33		
MG44287	23	MG45031	9	MG45629	44	MG46130	33		
MG44288	23	MG45032	9	MG45630	44	MG46133	13		
MG44289	23	MG45033	9	MG45631	44	MG46134	35		
MG44290	23	MG45034	9	MG45632	39	MG46155	37		
MG44291	23	MG45035	9	MG45633	39	MG46172	43		
MG44292	23	MG45036	9	MG45634	39	MG46173	43		
MG44293	23	MG45037	9	MG45635	39	MG9153	22		
MG44294	23	MG45038	9	MG45636	39	MG9156	22		
MG44295	23	MG45039	9	MG45637	39	MG9481	23		
MG44296	23	MG45040	9	MG45638	39	MG9482	23		
MG44434	11	MG45041	9	MG45639	39	MG9487	23		
MG44435	11	MG45042	9	MG45670	39	MG9488	23		
MG44527	47	MG45043	9	MG45671	39	MG9495	25		
MG44631	37	MG45044	9	MG45672	39	MG9527	22		
MG44641	35	MG45045	9	MG45673	39	MG9529	22		
MG44643	10	MG45046	9	MG45674	39	MG9531	22		
MG44644	10	MG45047	9	MG45675	39	MG9534	22		
MG44645	10	MG45048	9	MG45676	39	MG9537	22		
MG44646	10	MG45049	9	MG45677	40	MG9538	22		
MG44647	10	MG45050	9	MG45678	40	MG9539	22		
MG44724	30	MG45051	9	MG45679	40	MG9541	22		
MG44725	30	MG45052	9	MG45680	40	MG9543	22		
MG44726	30	MG45053	9	MG45681	40	MG9545	22		











